



High color • Wide screen •
User-friendly
No.18, Xinglong Rd., Taoyuan City
33068, Taiwan

DOP-107DV

Instruction Sheet

(1) General precautions

Thank you for purchasing this product. This DOP-107DV instruction sheet provides information for the DOP-107DV series HMI. Before using this product, read through this instruction sheet carefully to ensure the correct use of the product. Keep this sheet handy for quick reference whenever needed. Before finishing reading this sheet, follow the instructions below:

- Install the product in an indoor location, which is free of vapor and corrosive and inflammable gas.
- Refer to the wiring diagram when connecting the wires.
- Ensure this product is correctly grounded. The grounding method must comply with the national electrical standard guidelines (refer to NFPA 70: National Electrical Code, 2005 Ed.).
- Do not disassemble the HMI or change the wiring when power is on.
- Do not touch the power supply when power is on, or it may cause electric shock.
- When the HMI displays a low power notification and requires a battery change, contact Delta or local distributors for the replacement. Do not change the batteries by yourself.
- This product can be used with other industrial automation equipment. Read through this sheet carefully and install the product according to the instructions to avoid danger.
- Cleaning method: use a dry cloth to clean the product.
- This product must be used at an altitude below 2,000 m (6561.68 ft).
- If the equipment is used in a manner not specified by the manufacturer, the protection function provided by the equipment may be impaired.
- For repair and maintenance, contact Delta Electronics, Inc. Address: No.18, Xinglong Rd., Taoyuan City, Taiwan. TEL: +886-3-3626301.

If you have any inquiry during operation, contact our local distributors or Delta Customer Service Center. The instruction sheet may be revised without prior notice. Contact our distributors or download the latest version from the Delta website (<http://www.deltaww.com.tw/ia>).

(2) Communication port pin assignment

DOP-107DV COM1

COM Port	Pin	MODE1		MODE2		MODE3	
		COM1 RS-232	COM2 RS-485	COM1 RS-485	COM2 RS-485	COM1 RS-232	COM2 RS-422
	1	-	-	D+	-	-	TXD+
	2	RXD	-	-	-	RXD	-
	3	TXD	-	-	-	TXD	-
	4	-	D+	-	D+	-	RXD+
	5	GND		GND		GND	
	6	-	-	D-	-	-	TXD-
	7	RTS	-	-	-	RTS	-
	8	CTS	-	-	-	CTS	-
	9	-	D-	-	D-	-	RXD-

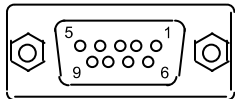

Note: the mark "-" means connection is not required.

(3) Description of each part

DOP-107DV (front view)

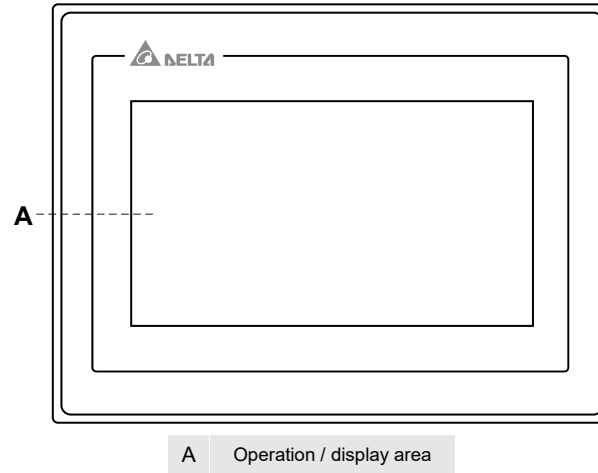

DOP-107DV (rear view)

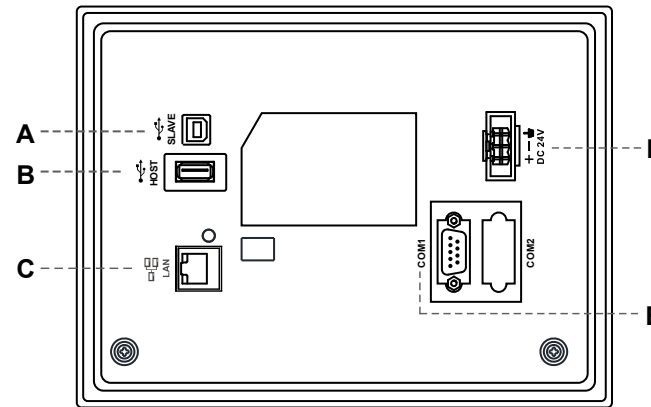

A	USB Slave	B	USB Host
C	Ethernet (LAN)	D	Power input connector (24AWG wire min.)
E	COM1	-	-

(4) Mounting dimensions

DOP-107DV

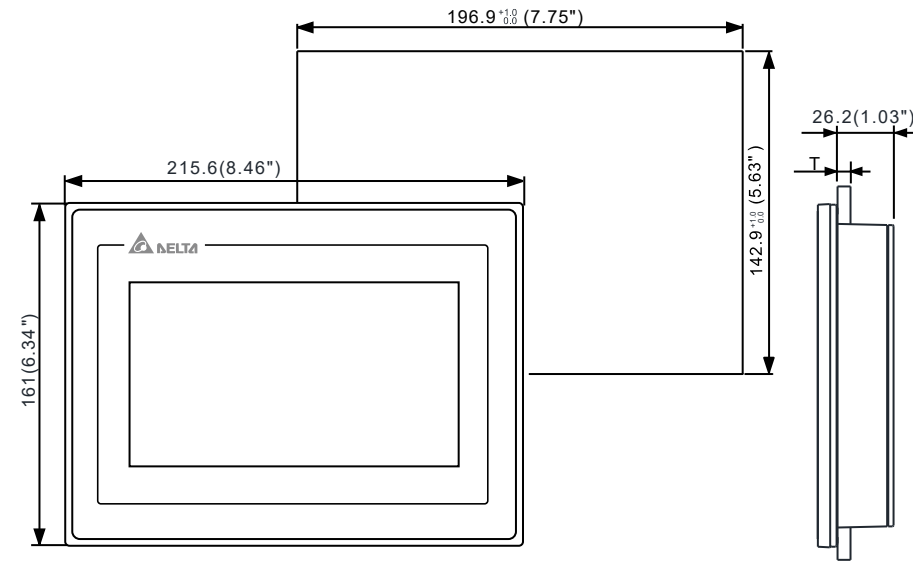

Note:
T = 1.6 mm - 6 mm (0.063" - 0.24")

Unit: mm (inch)

Operation temperature: 0°C to 50°C (32°F to 122°F)
Storage temperature: -20°C to 60°C (-4°F to 140°F)

(5) Installation and wiring

Precautions:

- Mount the HMI according to the following illustration. Incorrect installation direction may result in malfunction.
- To ensure the HMI is well ventilated, make sure there is sufficient space between the HMI and the adjacent objects or walls.
- This product should be used on a case or platform which conforms to enclosure Type 4X standard (for indoor use only).
- The maximum panel thickness for mounting must be no greater than 5 mm (0.2 inches).
- Use copper wires.

Installation diagram:

Step 1:
Put the waterproof gasket onto the HMI and then insert the HMI into the panel cutout.

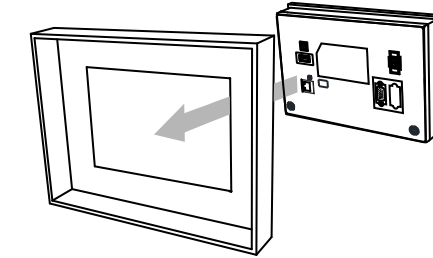

Step 2:
Place the fasteners into the slots and tighten the screws until reaching the panel cutouts.

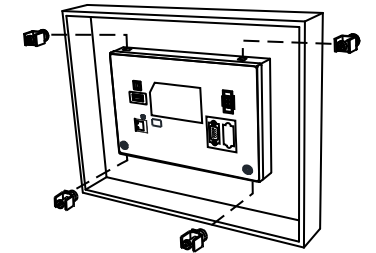

Step 3:
Tighten the screws with the torque between 0.5 N-M and 0.7 N-M to avoid damage to the plastic case.
DOP-107DV torque: 6.17 lb-inch (0.7 N-M)

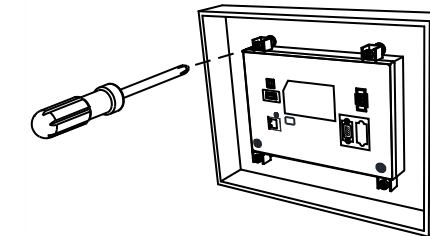

Step 4:
For heat dissipation, keep a minimum clearance of 60 mm (2.36 inches) and 45 mm (1.77 inches) respectively on the rear and bottom of the HMI.

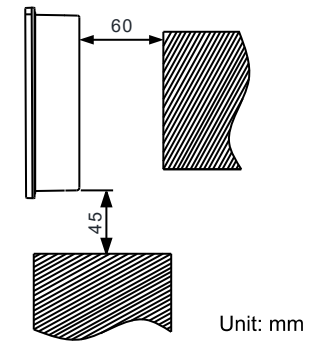

Unit: mm

Wiring:

Type	Wire gauge (AWG)	Stripped length	Torque
Solid	24 - 12	7 - 8 mm (0.28 - 0.31 inches)	5 kg-cm (4.3 lb-in)
Stranded	24 - 12	7 - 8 mm (0.28 - 0.31 inches)	5 kg-cm (4.3 lb-in)



Refer to the following diagram when wiring the power connector. The temperature rating of the cable must be greater than 75°C (167°F).

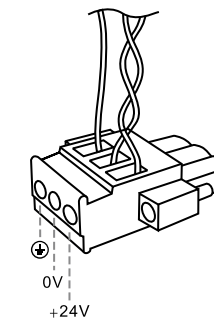

(6) Hardware specifications

Model		DOP-107DV
Display	Panel type	7" TFT LCD (65535 colors)
	Resolution	800 x 480 pixels
	Backlight	LED back light (half-life under room temperature 25°C > 20,000 hours) ¹
	Display range	154.08 mm * 85.92 mm
	Brightness	400 cd / m ² (Typ.)
CPU		ARM Cortex-A8 (800 MHz)
Flash ROM		256 Mbytes
RAM		256 Mbytes
Touchscreen		4-wire resistive touchscreen > 1,000,000 operated
Buzzer		Multi-tone frequency (2 - 4 kHz) / 80 dB
Network interface		1 port, 10/100 Mbps auto-detection (with built-in isolated power circuit) ²
USB		1 USB Slave Ver 2.0; 1 USB Host Ver 2.0
SD		N/A
Serial communication port	COM1	RS-232 (supports flow control) / RS-485 ²
	COM2	RS-422 / RS-485 ²
	COM3	N/A
Auxiliary function key		N/A
Calendar		Built-in
Cooling method		Natural cooling
Approvals		CE / UL (use shielding network cable and magnetic ring with the filter of 300 ohm / 100 MHz)
Panel waterproof level		IP65 / NEMA4 / UL TYPE 4X (indoor use only)
Operation voltage ²		DC +24V (-15% to +15%) (use an isolated power supply) Supplied by Class 2 or SELV circuit (isolated from MAINS by double insulation)
Leakage current		500 V _{AC} for 1 minute (between DC24V terminal and FG terminal)
Power consumption ³		8.8 W (Max) ³
Backup battery		3V lithium battery CR2032 x 1
Backup battery life		About 3 years or more at 25°C (77°F) (subject to operation temperature and condition)
Operation temperature		0°C to 50°C (32°F to 122°F)
Storage temperature		-20°C to +60°C (-4°F to 140°F)
Operating environment		10% to 90% RH [0 to 40°C (32°F to 104°F)], 10% to 55% RH [41 to 50°C (105.8°F to 122°F)], pollution degree: 2
Vibration resistance		Conforms to IEC61131-2: continuous vibration 5 Hz - 8.3 Hz with amplitude 3.5 mm; 8.3 Hz - 150 Hz with amplitude 1G
Shock resistance		Conforms to IEC60068-2-27: 11 ms, 15 G Peak, in X, Y, Z directions each for 6 times
Dimensions (W) x (H) x (D) mm		215 x 161 x 35.5
Mounting dimensions (W) x (H) mm		196.9 x 142.9
Weight		Approx. 700 g

Note:

- The half-life of the backlight is defined as the maximum luminance being reduced by 50% when the maximum drive current is supplied to the HMI. The life of LED backlight shown here is estimated at the room temperature of 25°C (77°F) with ambient humidity.
- The withstand voltage of the isolated power circuit is 1500V peak for 1 minute.
- The HMI power consumption is the power consumed when the HMI is not connecting with other peripheral devices. To ensure normal operation of the HMI, the recommended capacity of the power supply is 1.5 to 2 times of the specified power consumption.
- Isolated power supply is recommended.
- For the programming software DOPSoft of DOP-100 series and its user manual, you can download them at <http://www.delta.com.tw/ia>.
- DOP-100 series can be used with other industrial automation equipment. Read through this sheet carefully and install the product according to the instructions to avoid danger.