

**2 CO forcibly guided contacts relay interface modules, 15.8 mm wide**

**Type 48.12**

- 2 CO 8 A
- Screw terminals
- Relay with forcibly guided contacts according to EN 50205 Type B
- 35 mm rail (EN 60715) mounting
- Cadmium-free contact material

48.12  
Screw terminal



**48.12**



- 2 CO 8 A
- Forcibly guided contacts relay
- Screw terminals

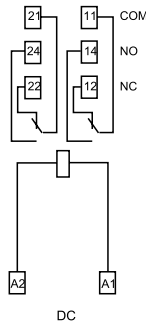

According to EN 50205 only 1 NO and 1 NC (11-14 and 21-22 or 11-12 and 21-24) shall be used as forcibly guided contacts.

For outline drawing see page 9

**Contact specification**

Contact configuration		2 CO (DPDT)
Rated current/Maximum peak current	A	8/15
Rated voltage/Maximum switching voltage	V AC	250/400
Rated load AC1	VA	2000
Rated load AC15 (230 V AC)	VA	500
Single phase motor rating (230 V AC)	kW	0.37
Breaking capacity DC1: 30/110/220 V	A	8/0.65/0.2
Minimum switching load	mW (V/mA)	500 (10/10)
Standard contact material		AgNi

**Coil specification**

Nominal voltage (U <sub>N</sub> )	V AC (50/60 Hz)	—
	V DC	12 - 24
Rated power AC/DC	VA (50 Hz)/W	—/0.7
Operating range	AC	—
	DC	(0.75...1.2)U <sub>N</sub>
Holding voltage	AC/DC	—/0.4 U <sub>N</sub>
Must drop-out voltage	AC/DC	—/0.1 U <sub>N</sub>

**Technical data**

Mechanical life AC/DC	cycles	—/10 · 10 <sup>6</sup>
Electrical life at rated load AC1	cycles	100 · 10 <sup>3</sup>
Operate/release time	ms	10/4
Insulation between coil and contacts (1.2/50 μs)	kV	6 (8 mm)
Dielectric strength between open contacts	V AC	1500
Ambient temperature range	°C	-40...+70
Protection category		IP 20

**Approvals relay** (according to type)



1 CO relay interface modules,  
15.8 mm wide

Ideal interface for PLC and electronic systems

**Type 48.P3**

- 1 CO 10 A
- Push-in terminals

**Type 48.31**

- 1 CO 10 A
- Screw terminals

- AC coils or DC sensitive coils
- Supply status indication and EMC coil suppression module as standard
- Identification label
- UL Listing (certain relay/socket combinations)
- 35 mm rail (EN 60715) mounting
- Cadmium-free contact material

48.P3  
Push-in terminal



48.31  
Screw terminal



**NEW** 48.P3



- 1 CO 10 A
- Push-in terminals

48.31

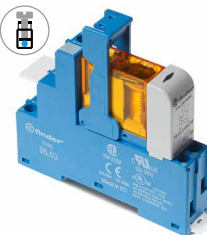

- 1 CO 10 A
- Screw terminals

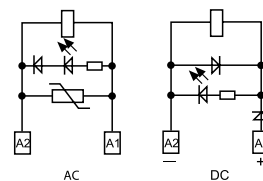
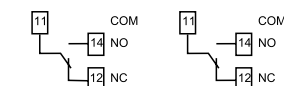
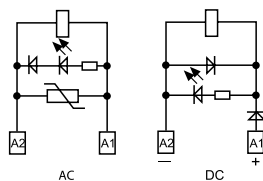
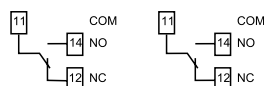

For outline drawing see page 9

**Contact specification**

Contact configuration		1 CO (SPDT)	1 CO (SPDT)
Rated current/Maximum peak current	A	10/20	10/20
Rated voltage/ Maximum switching voltage	V AC	250/400	250/400
Rated load AC1	VA	2500	2500
Rated load AC15 (230 V AC)	VA	500	500
Single phase motor rating (230 V AC)	kW	0.37	0.37
Breaking capacity DC1: 30/110/220 V	A	10/0.3/0.12	10/0.3/0.12
Minimum switching load	mW (V/mA)	300 (5/5)	300 (5/5)
Standard contact material		AgNi	AgNi

**Coil specification**

Nominal voltage ( $U_N$ )	V AC (50/60 Hz)	12 - 24 - 110 - 120 - 230	12 - 24 - 110 - 120 - 230
	V DC	12 - 24 - 125	12 - 24 - 125
Rated power AC/sens. DC	VA (50 Hz)/W	1.2/0.5	1.2/0.5
Operating range	AC	$(0.8 \dots 1.1) U_N$	$(0.8 \dots 1.1) U_N$
	sens. DC	$(0.73 \dots 1.5) U_N$	$(0.73 \dots 1.5) U_N$
Holding voltage	AC/DC	$0.8 U_N / 0.4 U_N$	$0.8 U_N / 0.4 U_N$
Must drop-out voltage	AC/DC	$0.2 U_N / 0.1 U_N$	$0.2 U_N / 0.1 U_N$

**Technical data**

Mechanical life	cycles	$10 \cdot 10^6$	$10 \cdot 10^6$
Electrical life at rated load AC1	cycles	$200 \cdot 10^3$	$200 \cdot 10^3$
Operate/release time	ms	7/4 (AC) - 12/12 (DC)	7/4 (AC) - 12/12 (DC)
Insulation between coil and contacts ( $1.2/50 \mu\text{s}$ )	kV	6 (8 mm)	6 (8 mm)
Dielectric strength between open contacts	V AC	1000	1000
Ambient temperature range	$^{\circ}\text{C}$	-40...+70	-40...+70
Protection category		IP 20	IP 20

**Approvals relay** (according to type)



**2 CO relay interface modules,  
15.8 mm wide**

**Ideal interface for PLC and electronic systems**

**Type 48.P5**

- 2 CO 8 A
- Push-in terminals

**Type 48.52**

- 2 CO 8 A
- Screw terminals

- AC coils or DC sensitive coils
- Supply status indication and EMC coil suppression module as standard
- Identification label
- UL Listing (certain relay/socket combinations)
- 35 mm rail (EN 60715) mounting
- Cadmium-free contact material

48.P5

Push-in terminal



48.52

Screw terminal



**NEW 48.P5**

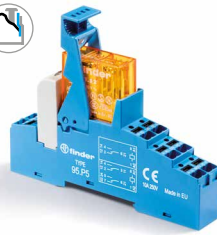

- 2 CO 8 A
- Push-in terminals

**48.52**

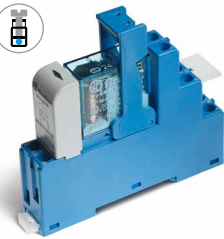

- 2 CO 8 A
- Screw terminals

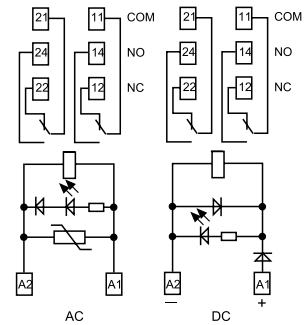
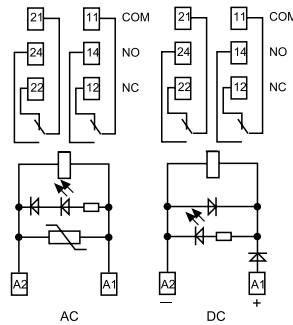

For outline drawing see page 9

**Contact specification**

Contact configuration		2 CO (DPDT)	2 CO (DPDT)
Rated current/Maximum peak current	A	8/15	8/15
Rated voltage/ Maximum switching voltage	V AC	250/250	250/250
Rated load AC1	VA	2000	2000
Rated load AC15 (230 V AC)	VA	400	400
Single phase motor rating (230 V AC)	kW	0.3	0.3
Breaking capacity DC1: 30/110/220 V	A	8/0.3/0.12	8/0.3/0.12
Minimum switching load	mW (V/mA)	300 (5/5)	300 (5/5)
Standard contact material		AgNi	AgNi

**Coil specification**

Nominal voltage (U <sub>N</sub> )	V AC (50/60 Hz)	12 - 24 - 110 - 120 - 230	12 - 24 - 110 - 120 - 230
	V DC	12 - 24 - 125	12 - 24 - 125
Rated power AC/sens. DC	VA (50 Hz)/W	1.2/0.5	1.2/0.5
Operating range	AC	(0.8...1.1)U <sub>N</sub>	(0.8...1.1)U <sub>N</sub>
	sens. DC	(0.73...1.5)U <sub>N</sub>	(0.73...1.5)U <sub>N</sub>
Holding voltage	AC/DC	0.8 U <sub>N</sub> / 0.4 U <sub>N</sub>	0.8 U <sub>N</sub> / 0.4 U <sub>N</sub>
Must drop-out voltage	AC/DC	0.2 U <sub>N</sub> / 0.1 U <sub>N</sub>	0.2 U <sub>N</sub> / 0.1 U <sub>N</sub>

**Technical data**

Mechanical life	cycles	10 · 10 <sup>6</sup>	10 · 10 <sup>6</sup>
Electrical life at rated load AC1	cycles	100 · 10 <sup>3</sup>	100 · 10 <sup>3</sup>
Operate/release time	ms	7/4 (AC) - 12/12 (DC)	7/4 (AC) - 12/12 (DC)
Insulation between coil and contacts (1.2/50 μs)	kV	6 (8 mm)	6 (8 mm)
Dielectric strength between open contacts	V AC	1000	1000
Ambient temperature range	°C	-40...+70	-40...+70
Protection category		IP 20	IP 20

**Approvals relay** (according to type)



1 CO relay interface modules,  
15.8 mm wide  
Ideal interface for PLC and electronic systems

**Type 48.P6**

- 1 CO 16 A
- Push-in terminals

**Type 48.61**

- 1 CO 16 A
- Screw terminals

- AC coils or DC sensitive coils
- Supply status indication and EMC coil suppression module as standard
- Identification label
- UL Listing (certain relay/socket combinations)
- 35 mm rail (EN 60715) mounting
- Cadmium-free contact material available

48.P6  
Push-in terminal



48.61  
Screw terminal



**NEW 48.P6**

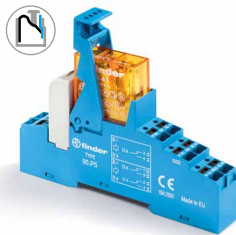

- 1 CO 16 A
- Push-in terminals

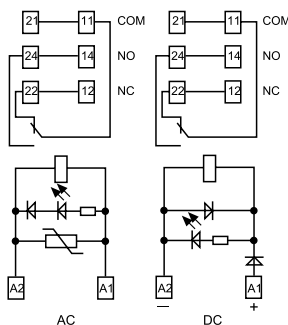

\* For currents > 10 A, contact terminals must be connected in parallel (21 with 11, 24 with 14, 22 with 12).

**48.61**



- 1 CO 16 A
- Screw terminals

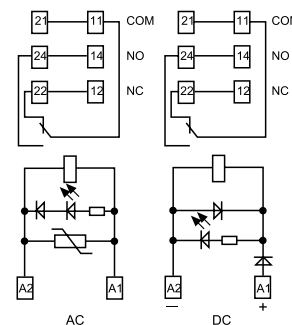

\* For currents > 10 A, contact terminals must be connected in parallel (21 with 11, 24 with 14, 22 with 12).

For outline drawing see page 9

**Contact specification**

Contact configuration		1 CO (SPDT)	1 CO (SPDT)
Rated current/Maximum peak current	A	16*/30	16*/30
Rated voltage/Maximum switching voltage	V AC	250/400	250/400
Rated load AC1	VA	4000	4000
Rated load AC15 (230 V AC)	VA	750	750
Single phase motor rating (230 V AC)	kW	0.55	0.55
Breaking capacity DC1: 30/110/220 V	A	16/0.3/0.12	16/0.3/0.12
Minimum switching load	mW (V/mA)	500 (10/5)	500 (10/5)
Standard contact material		AgCdO	AgCdO

**Coil specification**

Nominal voltage (U <sub>N</sub> )	V AC (50/60 Hz)	12 - 24 - 110 - 120 - 230	12 - 24 - 110 - 120 - 230
	V DC	12 - 24 - 125	12 - 24 - 125
Rated power AC/sens. DC	VA (50 Hz)/W	1.2/0.5	1.2/0.5
Operating range	AC	(0.8...1.1)U <sub>N</sub>	(0.8...1.1)U <sub>N</sub>
	sens. DC	(0.8...1.5)U <sub>N</sub>	(0.8...1.5)U <sub>N</sub>
Holding voltage	AC/DC	0.8 U <sub>N</sub> / 0.4 U <sub>N</sub>	0.8 U <sub>N</sub> / 0.4 U <sub>N</sub>
Must drop-out voltage	AC/DC	0.2 U <sub>N</sub> / 0.1 U <sub>N</sub>	0.2 U <sub>N</sub> / 0.1 U <sub>N</sub>

**Technical data**

Mechanical life	cycles	10 · 10 <sup>6</sup>	10 · 10 <sup>6</sup>
Electrical life at rated load AC1	cycles	100 · 10 <sup>3</sup>	100 · 10 <sup>3</sup>
Operate/release time	ms	7/4 (AC) - 12/12 (DC)	7/4 (AC) - 12/12 (DC)
Insulation between coil and contacts (1.2/50 μs)	kV	6 (8 mm)	6 (8 mm)
Dielectric strength between open contacts	V AC	1000	1000
Ambient temperature range	°C	-40...+70	-40...+70
Protection category		IP 20	IP 20

**Approvals relay** (according to type)



**2 CO relay interface modules,  
15.8 mm wide**  
**Ideal interface for PLC and electronic systems**

**Type 48.P8**

- 2 CO 10 A
- Push-in terminals

**Type 48.62**

- 2 CO 10 A
- Screw terminals

- DC sensitive coils
- Supply status indication and EMC coil suppression module as standard
- Identification label
- UL Listing (certain relay/socket combinations)
- 35 mm rail (EN 60715) mounting
- Cadmium-free contact material

48.P8  
Push-in terminal



48.62  
Screw terminal



**NEW 48.P8**

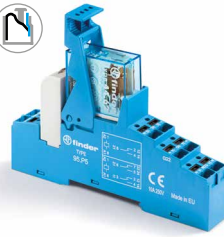

- 2 CO 10 A
- Push-in terminals

**48.62**

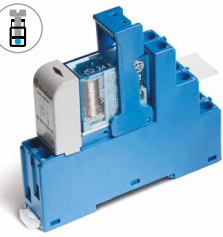

- 2 CO 10 A
- Screw terminals

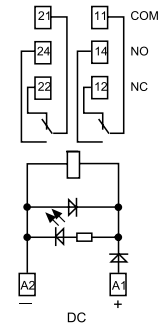
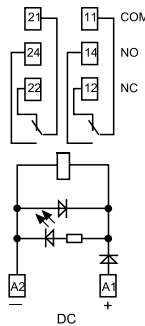

For outline drawing see page 9

**Contact specification**

Contact configuration		2 CO (DPDT)	2 CO (DPDT)
Rated current/Maximum peak current	A	10/20	10/20
Rated voltage/ Maximum switching voltage	V AC	250/400	250/400
Rated load AC1	VA	2500	2500
Rated load AC15 (230 V AC)	VA	500	500
Single phase motor rating (230 V AC)	kW	0.37	0.37
Breaking capacity DC1: 30/110/220 V	A	10/0.3/0.12	10/0.3/0.12
Minimum switching load	mW (V/mA)	300 (5/5)	300 (5/5)
Standard contact material		AgNi	AgNi

**Coil specification**

Nominal voltage ( $U_N$ )	V AC (50/60 Hz)	—	—
	V DC	12 - 24 - 125	12 - 24 - 125
Rated power AC/sens. DC	VA (50 Hz)/W	—/0.5	—/0.5
Operating range	AC	—	—
	sens. DC	$(0.8 \dots 1.5)U_N$	$(0.8 \dots 1.5)U_N$
Holding voltage	AC/DC	—/0.4 $U_N$	—/0.4 $U_N$
Must drop-out voltage	AC/DC	—/0.1 $U_N$	—/0.1 $U_N$

**Technical data**

Mechanical life	cycles	$20 \cdot 10^6$	$20 \cdot 10^6$
Electrical life at rated load AC1	cycles	$100 \cdot 10^3$	$100 \cdot 10^3$
Operate/release time	ms	12/12 (DC)	12/12 (DC)
Insulation between coil and contacts (1.2/50 $\mu$ s)	kV	6 (8 mm)	6 (8 mm)
Dielectric strength between open contacts	V AC	1000	1000
Ambient temperature range	$^{\circ}$ C	-40...+70	-40...+70
Protection category		IP 20	IP 20

**Approvals relay** (according to type)





**Contact specification**

**F 48 - Electrical life (AC) v contact current**  
Types 48.P3/P6/31/61

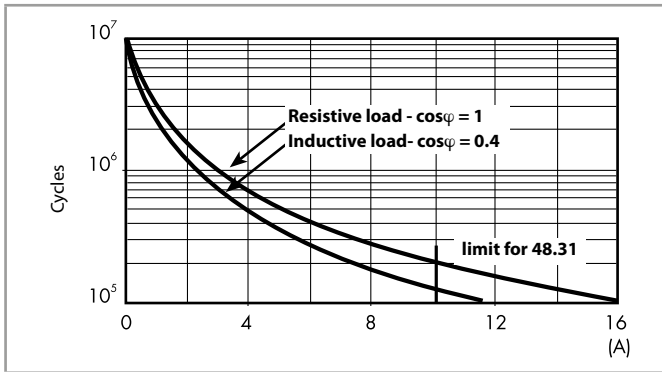

**F 48 - Electrical life (AC) v contact current**  
Types 48.P8/62

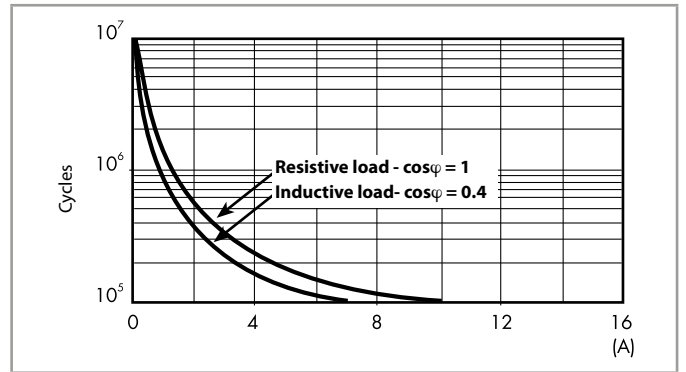

**F 48 - Electrical life (AC) v contact current**  
Types 48.P5/52

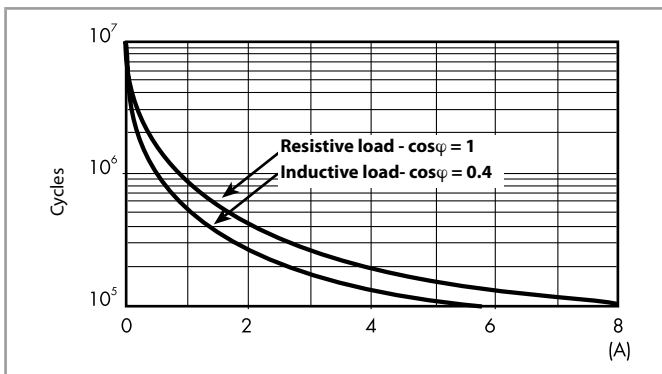

**F 48 - Electrical life (AC) v contact current**  
Type 48.12

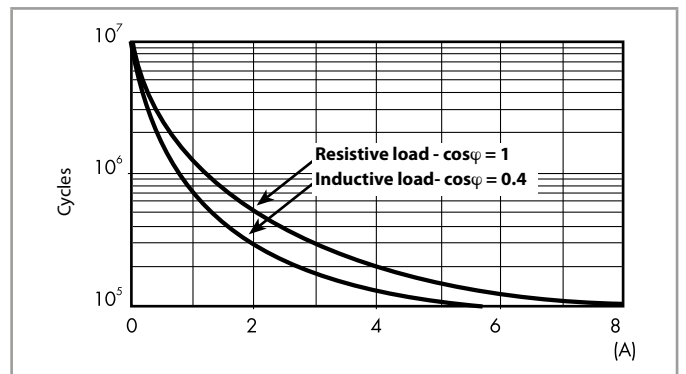

**H 48 - Maximum DC1 breaking capacity**  
Types 48.P3/P5/P6/31/52/61

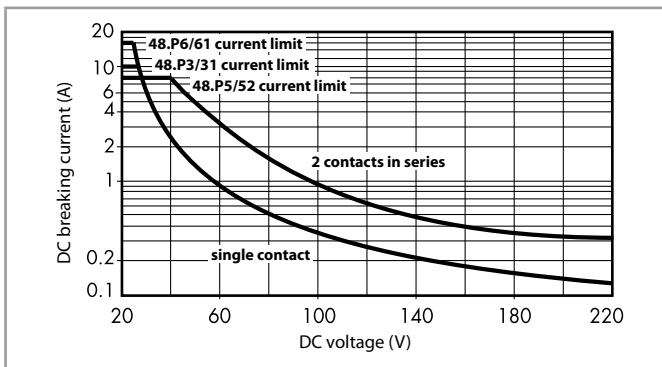

**H 48 - Maximum DC1 breaking capacity**  
Types 48.P8/62

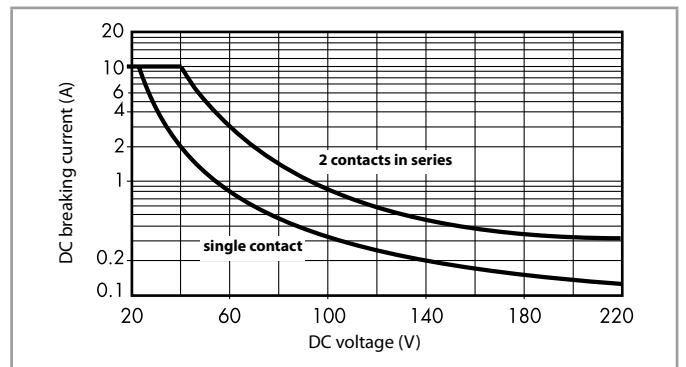

**H 48 - Maximum DC1 breaking capacity**  
Type 48.12

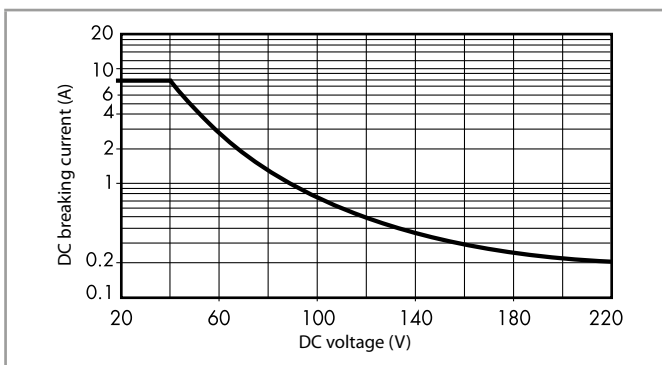

- When switching a resistive load (DC1) having voltage and current values under the curve, an electrical life of  $\geq 100 \cdot 10^3$  can be expected.
  - In the case of DC13 loads, the connection of a diode in parallel with the load will permit a similar electrical life as for a DC1 load.
- Note: the release time for the load will be increased.

## Coil specifications

### DC coil data (0.5 W sensitive)

Nominal voltage $U_N$ V	Coil code	Operating range		Rated coil consumption I at $U_N$ mA
		$U_{min}^*$ V	$U_{max}$ V	
12	7.012	8.8	18	41
24	7.024	17.5	36	22.2
125	7.125	91	188	4

\*  $U_{min} = 0.8 U_N$  for 48.61, 48.62, 48.P6, 48.P8

### AC coil data

Nominal voltage $U_N$ V	Coil code	Operating range		Rated coil consumption I at $U_N$ (50 Hz) mA
		$U_{min}$ V	$U_{max}$ V	
12	8.012	9.6	13.2	90.5
24	8.024	19.2	26.4	46
110	8.110	88	121	10.1
120	8.120	96	132	11.8
230	8.230	184	253	7.0

### DC coil data, 2 pole relay - Type 48.12

Nominal voltage $U_N$ V	Coil code	Operating range		Resistance R $\Omega$	Rated coil consumption I at $U_N$ mA
		$U_{min}$ V	$U_{max}$ V		
12	9.012	9	14.4	205	58.5
24	9.024	18	28.8	820	29.3

### R 48 - DC coil operating range v ambient temperature

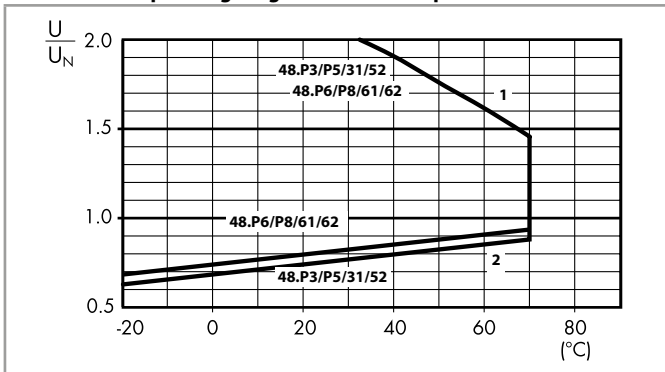

- 1 - Max. permitted coil voltage.  
2 - Min. pick-up voltage with coil at ambient temperature.

### R 48 - AC coil operating range v ambient temperature

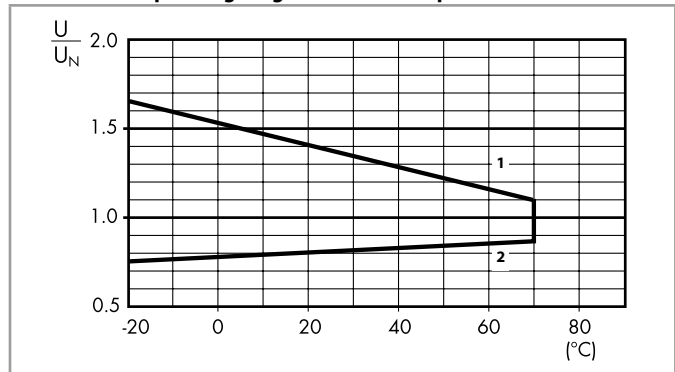

- 1 - Max. permitted coil voltage.  
2 - Min. pick-up voltage with coil at ambient temperature.

### R 48 - DC coil operating range v ambient temperature

#### Type 48.12

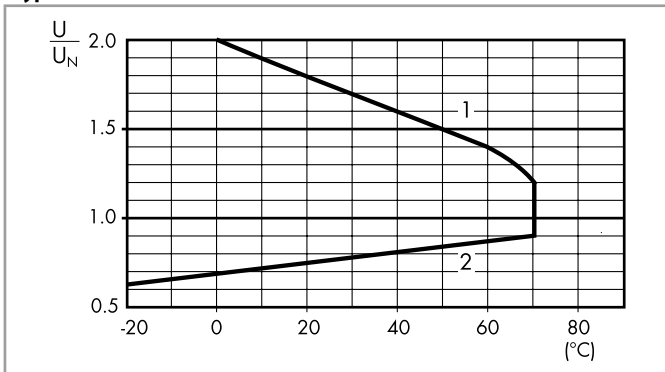

- 1 - Max. permitted coil voltage.  
2 - Min. pick-up voltage with coil at ambient temperature.



**Combinations**

Code	Type of socket	Type of relay	Module	Retaining clip
48.12	95.05.0	50.12	—	095.71
48.31	95.03	40.31	99.02	095.01
48.52	95.05	40.52	99.02	095.01
48.61	95.05	40.61	99.02	095.01
48.62	95.05	44.62	99.02	095.01
48.P3	95.P3	40.31	99.02	095.91.3
48.P5	95.P5	40.52	99.02	095.91.3
48.P6	95.P5	40.61	99.02	095.91.3
48.P8	95.P5	44.62	99.02	095.91.3

**Outline drawing**

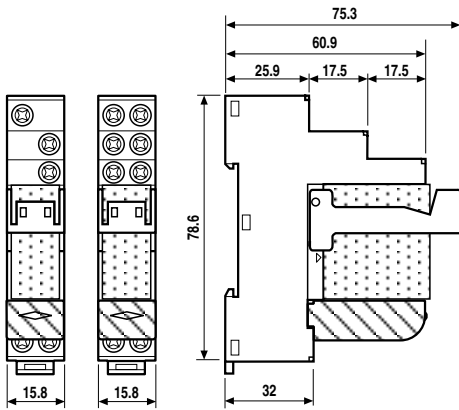

48.31 48.52 / 48.61 / 48.62  
Screw terminal

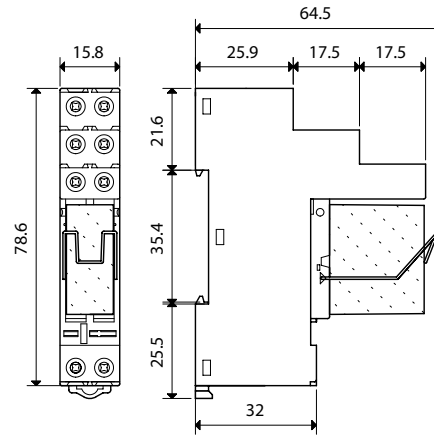

48.12  
Screw terminal

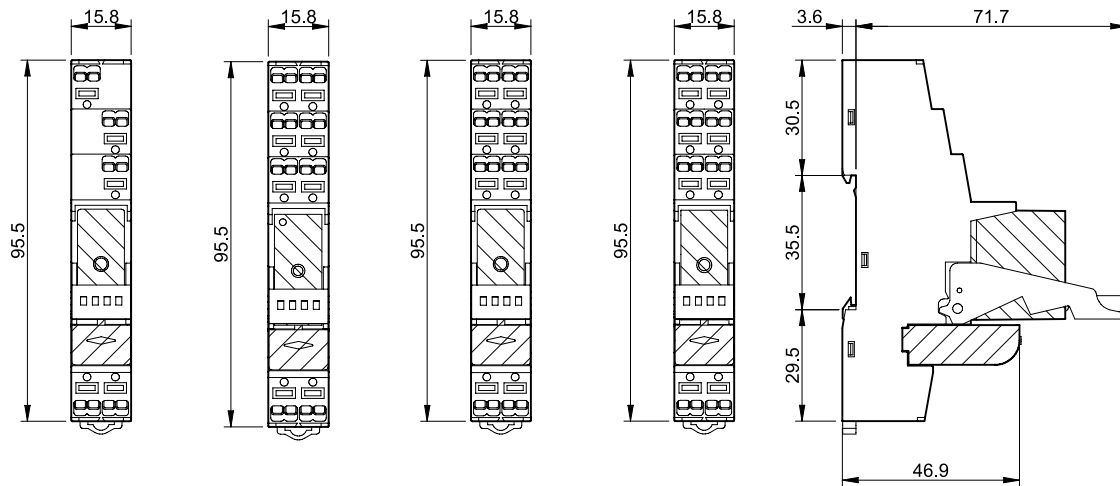

48.P3 48.P5 48.P6 48.P8  
Push-in terminal



Accessories



097.58

<b>8-way jumper link</b> for type 48.P3/P5/P6/P8	097.58
Rated values	10 A - 250 V

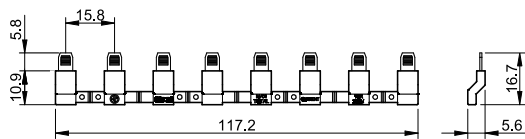

097.52

<b>2-way jumper link</b> for type 48.P3/P5/P6/P8	097.52
Rated values	10 A - 250 V

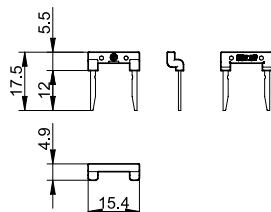

097.42

<b>2-way jumper link</b> for type 48.P3/P5/P6/P8	097.42
Rated values	10 A - 250 V

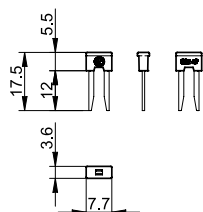

097.00

<b>Marker tag holder</b> for type 48.P3/P5/P6/P8 and 48.12/31/52/61/62	097.00
--	--------

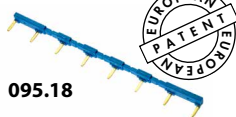
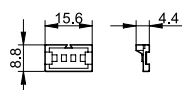

095.18

<b>8-way jumper link</b> for screw terminal version	095.18 (blue)	095.18.0 (black)
Rated values	10 A - 250 V	

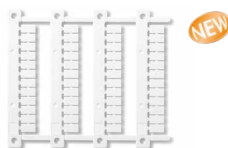
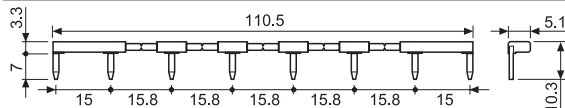

060.48

<b>Sheet of marker tags (CEMBRE'S Thermal transfer printers)</b> , plastic, 48 tags, 6 x 12 mm	060.48
--	--------



060.72

<b>Sheet of marker tags (plotter printing)</b> , plastic, 72 tags, 6 x 12 mm	060.72
--	--------

Packaging codes

How to code and identify retaining clip and packaging options for sockets.

Example:

4 8 . P 5 . 7 . 0 2 4 . 0 0 5 0 S P A

A Standard packaging  
B Blister packaging

SP Plastic retaining clip