

**FLUKE®**

# 62 MAX/62 MAX +

Infrared Thermometer

**Users Manual**



PN 4060712

April 2012 Rev. 1, 11/12

© 2012 Fluke Corporation. All rights reserved. Printed in China.

Specifications are subject to change without notice.

All product names are trademarks of their respective companies.

## **LIMITED WARRANTY AND LIMITATION OF LIABILITY**

This Fluke product will be free from defects in material and workmanship for three years from the date of purchase. This warranty does not cover fuses, disposable batteries, or damage from accident, neglect, misuse, alteration, contamination, or abnormal conditions of operation or handling. Resellers are not authorized to extend any other warranty on Fluke's behalf. To obtain service during the warranty period, contact your nearest Fluke authorized service center to obtain return authorization information, then send the product to that Service Center with a description of the problem.

**THIS WARRANTY IS YOUR ONLY REMEDY. NO OTHER WARRANTIES, SUCH AS FITNESS FOR A PARTICULAR PURPOSE, ARE EXPRESSED OR IMPLIED. FLUKE IS NOT LIABLE FOR ANY SPECIAL, INDIRECT, INCIDENTAL OR CONSEQUENTIAL DAMAGES OR LOSSES, ARISING FROM ANY CAUSE OR THEORY.** Since some states or countries do not allow the exclusion or limitation of an implied warranty or of incidental or consequential damages, this limitation of liability may not apply to you.

Fluke Corporation  
P.O. Box 9090  
Everett, WA 98206-9090  
U.S.A.

Fluke Europe B.V.  
P.O. Box 1186  
5602 BD Eindhoven  
The Netherlands

# Table of Contents

Title	Page
Introduction.....	1
How to Contact Fluke .....	1
Safety Information .....	2
Maintenance .....	6
How to Change the Battery .....	6
How to Clean the Product .....	6
Specifications .....	7
Standards and Agency Approval .....	9
The Product .....	10



## ***Introduction***

The Fluke 62 MAX and 62 MAX + Infrared Thermometers (the Product) can determine the surface temperature by measuring the amount of infrared energy radiated by the target's surface. Note that the Japanese models indicate Celsius only.

### **Warning**

**Read all safety information before you use the Product.**

## ***How to Contact Fluke***

To contact Fluke, call one of the following telephone numbers:

- Technical Support USA: 1-800-44-FLUKE (1-800-443-5853)
- Calibration/Repair USA: 1-888-99-FLUKE (1-888-993-5853)
- Canada: 1-800-36-FLUKE (1-800-363-5853)
- Europe: +31 402-675-200
- Japan: +81-03-6714-3114
- Singapore: +65-6799-5655
- Anywhere in the world: +1-425-446-5500

Or, visit Fluke's website at [www.fluke.com](http://www.fluke.com).

To register your product, visit <http://register.fluke.com>.

To see, print, or download the latest manual supplement, visit <http://us.fluke.com/usen/support/manuals>.

## ***Safety Information***

A **Warning** identifies conditions and procedures that are dangerous to the user. A **Caution** identifies conditions and procedures that can cause damage to the Product or the equipment under test.

Table 1 tells you about symbols used on the Product and in this manual.



### **Warning**

**To prevent eye damage and personal injury:**

- **Read all safety Information before you use the Product.**
- **Do not use the Product if it operates incorrectly.**
- **Use the Product only as specified, or the protection supplied by the Product can be compromised.**
- **Before you use the Product, inspect the case. Do not use the Product if it appears damaged. Look for cracks or missing plastic.**





- **See emissivity information for actual temperatures. Reflective objects result in lower than actual temperature measurements. These objects pose a burn hazard.**
- **Do not look directly into the laser with optical tools (for example, binoculars, telescopes, microscopes). Optical tools can focus the laser and be dangerous to the eye.**
- **Do not look into the laser. Do not point laser directly at persons or animals or indirectly off reflective surfaces.**
- **Replace the batteries when the low battery indicator shows to prevent incorrect measurements.**
- **Do not use the Product around explosive gas, vapor, or in damp or wet environments.**
- **Use the Product only as specified or hazardous laser radiation exposure can occur.**

**Table 1. Symbols**

<b>Symbol</b>	<b>Meaning</b>	<b>Symbol</b>	<b>Meaning</b>
	Risk of danger. Important information. See Manual.		This product complies with the WEEE Directive (2002/96/EC) marking requirements. The affixed label indicates that you must not discard this electrical/electronic product in domestic household waste. Product Category: With reference to the equipment types in the WEEE Directive Annex I, this product is classed as category 9 "Monitoring and Control Instrumentation" product. Do not dispose of this product as unsorted municipal waste. Go to Fluke's website for recycling information.



**Table 1. Symbols (cont.)**

<b>Symbol</b>	<b>Meaning</b>	<b>Symbol</b>	<b>Meaning</b>
	Warning. Laser.		Conforms to European Union directives.
	Battery		Conforms to relevant Australian standards.
 沪制01120009号	Conforms to China Metrology Certification		

## ***Maintenance***

### **Caution**

**To avoid damage to the Product, do not leave the thermometer on or near objects of high temperature.**

#### ***How to Change the Battery***

To install or change the AA IEC LR06 battery, open the battery compartment and replace the battery as shown in Figure 16.

#### ***How to Clean the Product***

Use soap and water on a damp sponge or soft cloth to clean the Product case. Carefully wipe the surface with a moist cotton swab. The swab may be moistened with water. See Figure 17.

## Specifications

	<b>62 MAX</b>	<b>62 MAX +</b>
Temperature Range	-30 °C to 500 °C (-22 °F to 932 °F)	-30 °C to 650 °C (-22 °F to 1202 °F)
Accuracy (Calibration geometry with ambient temperature 23 °C ±2 °C)	<p>≥0 °C: ±1.5 °C or ±1.5 % of reading, whichever is greater (≥32 °F: ±3 °F or ±1.5 % of reading, whichever is greater)</p> <p>≥ -10 °C to &lt;0 °C: ±2 °C (≥14 °F to &lt;32 °F: ±4 °F)</p> <p>&lt; -10 °C: ±3 °C (&lt;14 °F: ±6 °F)</p>	<p>≥0 °C: ±1 °C or ±1 % of reading, whichever is greater (≥32 °F: ±2 °F or ±1 % of reading, whichever is greater)</p> <p>≥ -10 °C to &lt;0 °C: ±2 °C (≥14 °F to &lt;32 °F: ±4 °F)</p> <p>&lt; -10 °C: ±3 °C (&lt;14 °F: ±6 °F)</p>
Response Time (95 %)	<500 ms (95 % of reading)	<300 ms (95 % of reading)
Spectral Response	8 to 14 microns	
Emissivity	0.10 to 1.00	
Temperature Coefficient	±0.1 °C/°C or ±0.1 %/°C of reading (whichever is greater)	

## 62 MAX/62 MAX + Users Manual

---

Optical Resolution	10:1 (calculated at 90 % energy)	12:1 (calculated at 90 % energy)
Display Resolution	0.1 °C (0.2 °F)	
Repeatability (% of reading)	±0.8 % of reading or ±1.0 °C (2 °F), whichever is greater	±0.5 % of reading or ±0.5 °C (1 °F), whichever is greater
Power	1 AA IEC LR06 Battery	
Battery Life	10 hours with laser and backlight on	8 hours with laser and backlight on
Weight	255 g (8.99 oz)	
Size	(175 x 85 x 75) mm (6.88 x 3.34 x 2.95) inches	
Operating Temperature	0 °C to 50 °C (32 °F to 122 °F)	
Storage Temperature	-20 °C to 60 °C (-4 °F to 140 °F), (without battery)	
Operating Humidity	10 % to 90 % RH non-condensing @ 30 °C (86 °F)	
Operating Altitude	2000 meters above mean sea level	
Storage Altitude	12,000 meters above mean sea level	

***Infrared Thermometer***  
***Standards and Agency Approval***

---

Ingress Protection Rating	IP 54 per IEC 60529
Drop Test	3 meters
Vibration and Shock	IEC 60068-2-6 2.5 g, 10 to 200 Hz, IEC 60068-2-27, 50 g, 11 ms
EMC	EN 61326-1:2006 EN 61326-2:2006

***Standards and Agency Approval***

Compliance ..... EN/IEC 61010-1  
Laser Safety ..... EN 60825-1 Class 2  
Implement Standard ..... Q/SXAV37

## The Product

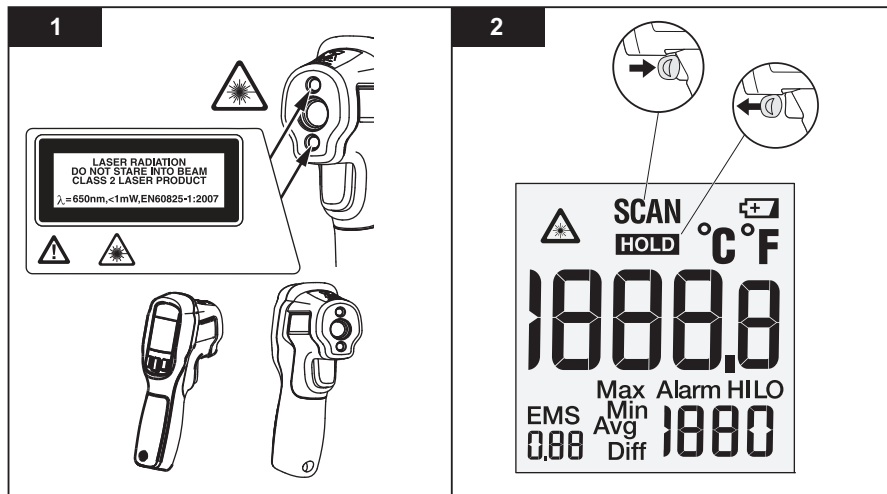

gtt01.eps

**3**

**4**

°F/°C

**5**

EMS

**5**

**6**

Max/Min/Avg/Diff

△ SCAN °F	△ SCAN °F	△ SCAN °F	△ SCAN °F
68.0	68.0	68.0	68.0
EMS 0.95 Max 90	EMS 0.95 Min 68	EMS 0.95 Avg 76	EMS 0.95 Diff 22

7

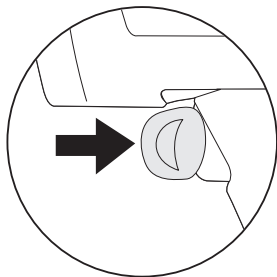
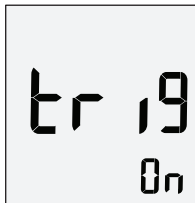

+

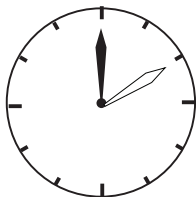

=

10 min



OFF

gtt16.eps



# Infrared Thermometer

## The Product

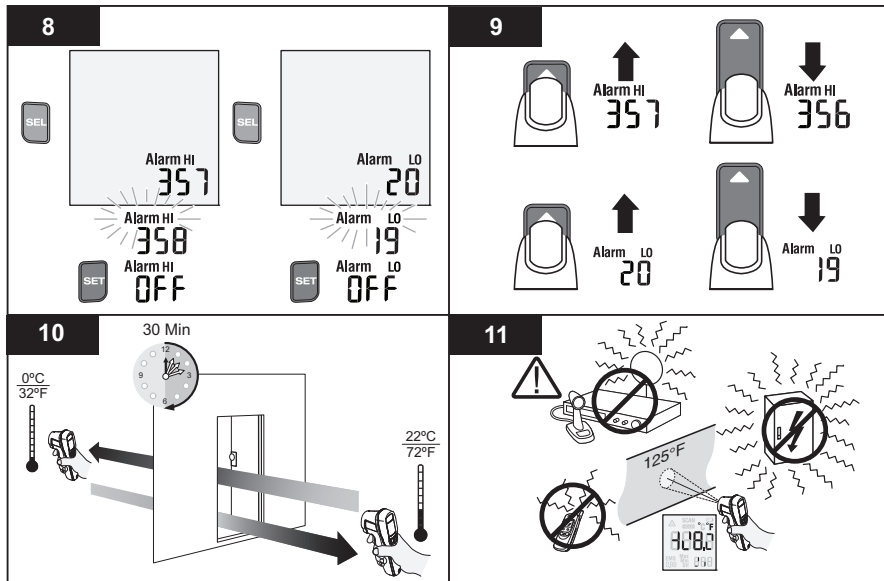

gtt15.eps

**62 MAX/62 MAX +**  
*Users Manual*

**12**

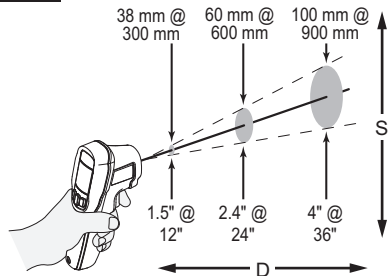

**62 MAX**  
 D:S = 10:1

**13**

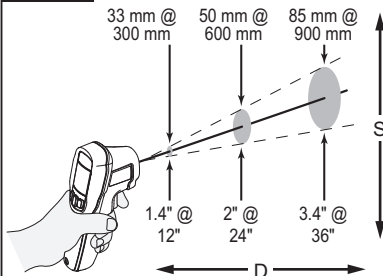

**62 MAX +**  
 D:S = 12:1

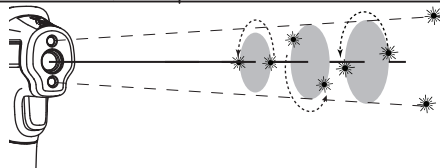

gtt08-11.eps

# Infrared Thermometer

## The Product

14

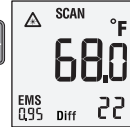
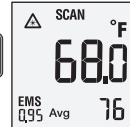
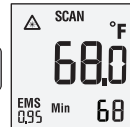
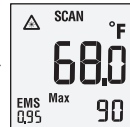
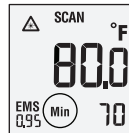
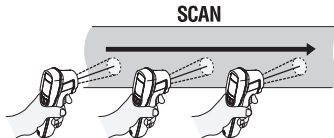
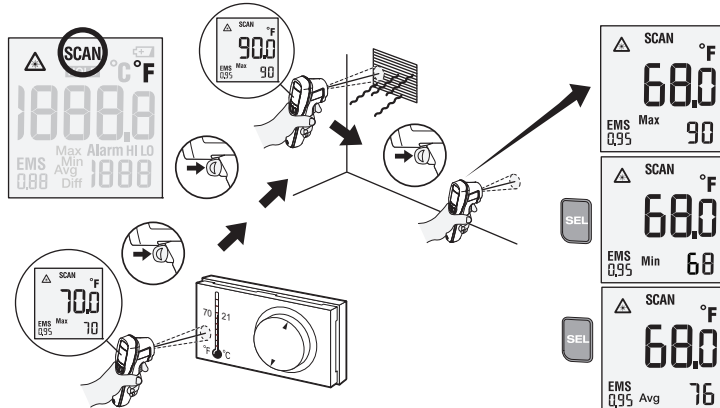

gtt03.eps

15

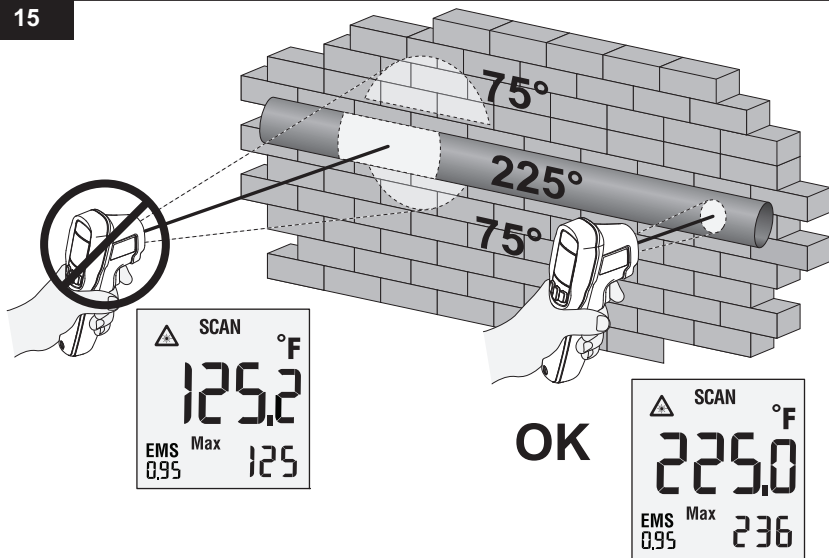

gtt04.eps

