

374/375/376

Clamp Meter

Users Manual



PN 3608883
July 2010

© 2010 Fluke Corporation. All rights reserved. Printed in China. Specifications are subject to change without notice.
All product names are trademarks of their respective companies.

Table of Contents

Title	Page
Introduction.....	1
How to Contact Fluke	2
Safety Information	3
The Meter	9
Specifications	19
Electrical Specifications.....	19
Mechanical Specifications	26
Environmental Specifications	27

Introduction

⚠⚠ Warning

Read "Safety Information" before you use the Meter.

The Fluke 374, 375, and 376 (the Meter) measure true-rms ac current and voltage, dc current and voltage, inrush current, resistance, and capacitance. The 375 and 376 also measure frequency and dc millivolts. The detachable iFlex (Flexible Current Probe) that is included with the 376 (optional with the 374 and 375) expands the measurement range to 2500 A ac. The Flexible Current Probe provides increased display flexibility and allows measurements of awkward sized conductors and improved wire access. The illustrations in this manual show the 376.

How to Contact Fluke

To contact Fluke, call one of the following telephone numbers:

- Technical Support USA: 1-800-44-FLUKE (1-800-443-5853)
- Calibration/Repair USA: 1-888-99-FLUKE (1-888-993-5853)
- Canada: 1-800-36-FLUKE (1-800-363-5853)
- Europe: +31 402-675-200
- Japan: +81-3-3434-0181
- Singapore: +65-738-5655
- Anywhere in the world: +1-425-446-5500

Or, visit Fluke's website at www.fluke.com.

To register your product, visit <http://register.fluke.com>.

To see, print, or download the latest manual supplement, visit <http://us.fluke.com/user/support/manuals>.

Safety Information

A **Warning** identifies conditions and actions that pose hazard(s) to the user. A **Caution** identifies conditions and procedures that could cause Meter damage, equipment under test damage, or permanent loss of data.

Symbols used on the Meter and in this manual are explained in Table 1.

Warning

To prevent possible electrical shock or personal injury, follow these guidelines:

- Use the Meter only as specified in this manual or the protection provided by the Meter can be compromised.
- Examine the case before you use the Meter. Look for cracks or missing plastic. Carefully look at the insulation around the connectors.
- Never measure current while the test leads are inserted into the input jacks.
- Make sure the battery door is closed and latched before operating the Meter.
- Remove the test leads from the Meter before the battery door is opened.
- Examine the test leads for damaged insulation or exposed metal. Check test lead continuity. Replace damaged test leads before using the Meter.
- Do not use the Meter if it operates incorrectly. Protection can be compromised. When in doubt, have the Meter serviced.

- Do not use the Meter around explosive gas, vapor or in damp or wet environments.
- Use only type AA batteries, properly installed in the Meter case, to power the Meter.
- When measuring current with the Jaw, keep fingers behind the Tactile Barrier. See "The Meter" ①.
- To avoid false readings that can lead to electrical shock and injury, replace the batteries as soon as the low battery indicator () appears.
- When servicing the Meter, use only specified replacement parts.
- Have the Meter serviced only by qualified service personnel.
- Be careful around voltages > 30 V ac rms, 42 V ac peak, or 60 V dc. Such voltages pose a shock hazard.
- Do not apply more than the rated voltage, as marked on the Meter, between the terminals or between any terminal and earth ground.
- When using the probes, keep fingers behind the finger guards on the probes.
- Connect the common test lead before connecting the live test lead. When disconnecting test leads, disconnect the live test lead first.
- Do not work alone so assistance can be rendered in an emergency.
- Use extreme caution when working around bare conductors or bus bars. Contact with the conductor could result in electric shock.







- **Adhere to local and national safety codes. Individual protective equipment must be used to prevent shock and arc blast injury where hazardous live conductors are exposed.**
- **Disconnect circuit power and discharge all high-voltage capacitors before you measure resistance, continuity, or capacitance.**
- **For the 374 and 375, do not measure ac/dc current in circuits carrying more than 1000 V or 600 A with the Meter Jaw.**
- **For the 376, do not measure ac/dc current in circuits carrying more than 1000 V or 1000 A with the Meter Jaw.**
- **Never operate the Meter with the back cover removed or the case open.**
- **Do not measure ac current in circuits carrying more than 1000 V or 2500 A with the Flexible Current Probe.**
- **Do not apply the Flexible Current Probe around or remove from HAZARDOUS LIVE conductors.**
- **Do not use the flexible current sensor if the inner contrasting insulation color is showing.**
- **Take special care during fitting and removal of the Flexible Current Probe. De-energize the installation under test or wear suitable protective clothing.**

⚠ Caution









To avoid possible damage to the Meter or to equipment under test:

- Use the proper jacks, function, and range for the measurement application.
- Clean the case and accessories with a damp cloth and mild detergent only. Do not use abrasives or solvents.

Table 1. Symbols

Symbol	Meaning	Symbol	Meaning
	AC (Alternating Current)		Earth ground
	DC (Direct Current)		Do not dispose of this product as unsorted municipal waste. Go to Fluke's website for recycling information.
	Hazardous voltage		Conforms to European Union directives.

Clamp Meters Safety Information

Symbol	Meaning	Symbol	Meaning
	Risk of Danger. Important information. See Manual.		Conforms to relevant North American Safety Standards.
	Battery. Low battery when shown on display.		Double insulated
	Examined and licensed by TÜV Product Services.		Conforms to relevant Australian standards.
	Do not apply to or remove from HAZARDOUS LIVE conductors.		Application around and removal from HAZARDOUS LIVE conductors is permitted.

Symbol	Meaning	Symbol	Meaning
CAT III	IEC Measurement Category III CAT III equipment has protection against transients in equipment in fixed-equipment installations, such as distribution panels, feeders and short branch circuits, and lighting systems in large buildings.	CAT IV	IEC Measurement Category IV CAT IV equipment has protection against transients from the primary supply level, such as an electricity Meter or an overhead or underground utility service.

Note

The Measurement Category (CAT) and voltage rating of any combination of test probe, test probe accessory, current clamp accessory, and the Meter is the LOWEST rating of any individual component.

The Meter

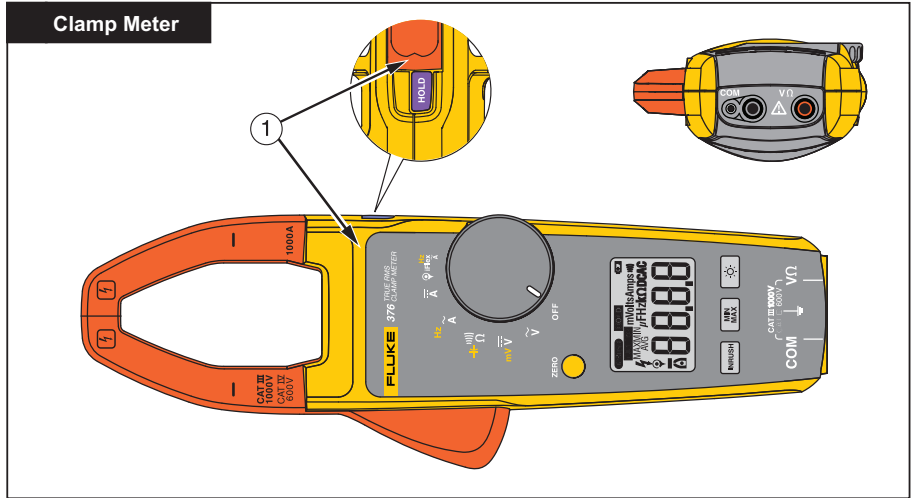

fig01.eps

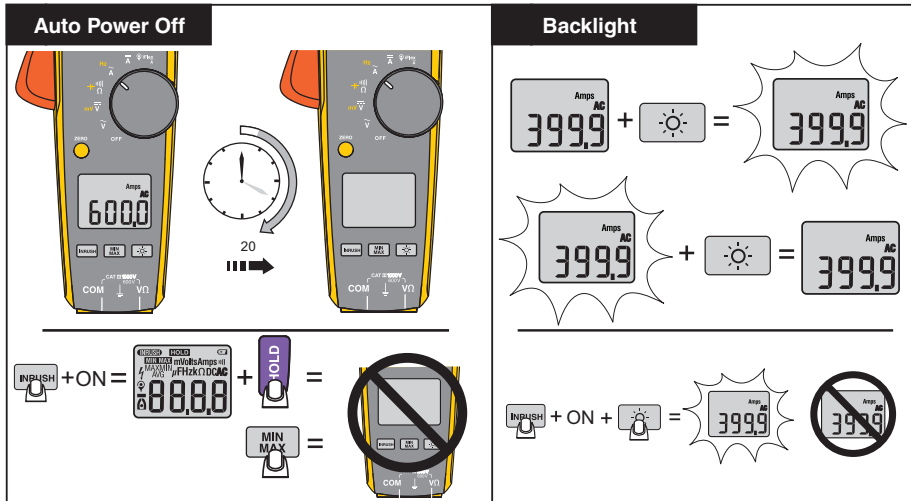
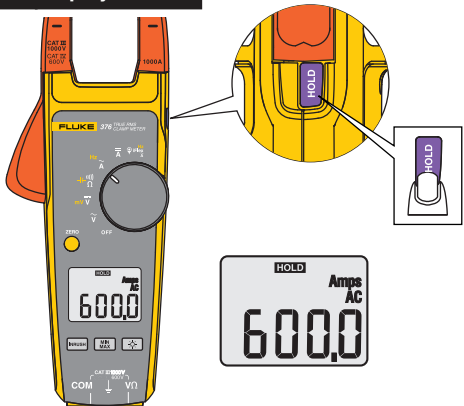

fig02_3.eps

Display Hold



The meter's display shows **600.0** with **Amps AC** and **MODE** indicators. A callout shows the **HOLD** button on the top of the meter's head. Another callout shows the **HOLD** button on a separate component.

MIN MAX AVG

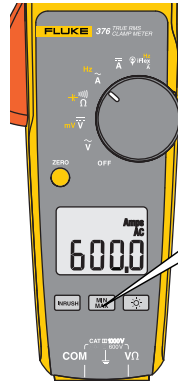

The meter's display shows **600.0** with **Amps AC** and **MODE** indicators. A callout shows the **MIN MAX AVG** button on the bottom of the meter's face.

MIN MAX = **MIN MAX**
1x = **MAX**

MIN MAX = **MIN MAX**
2x = **MIN**

MIN MAX = **MIN MAX**
3x = **AVG**

MIN MAX
2 sec = **Exit**

fig04_5.eps

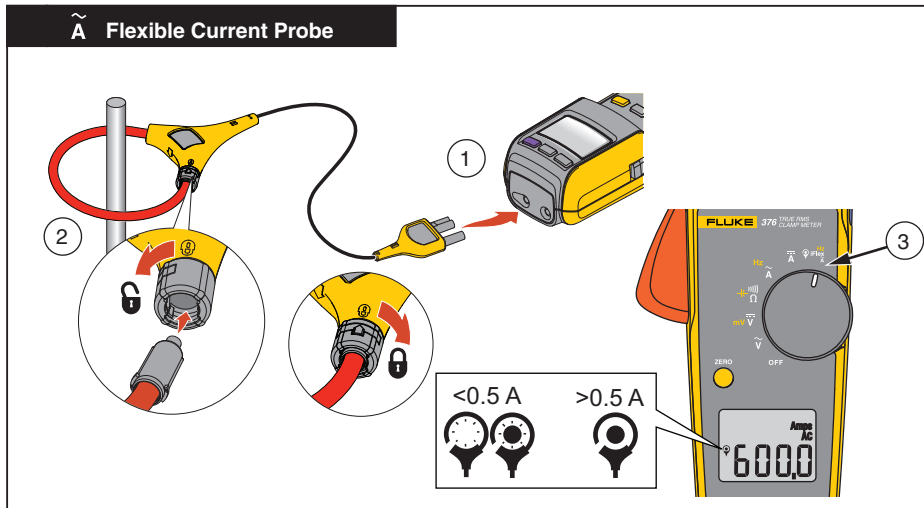
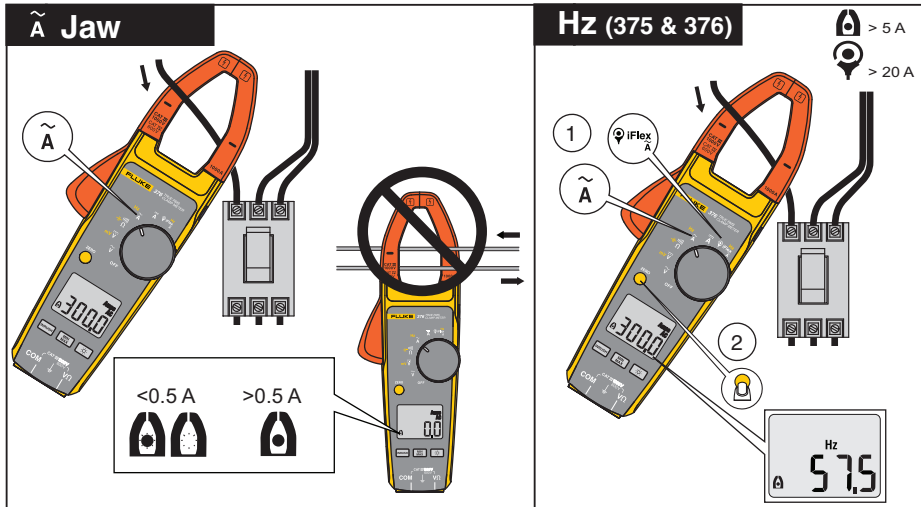

fig06.eps



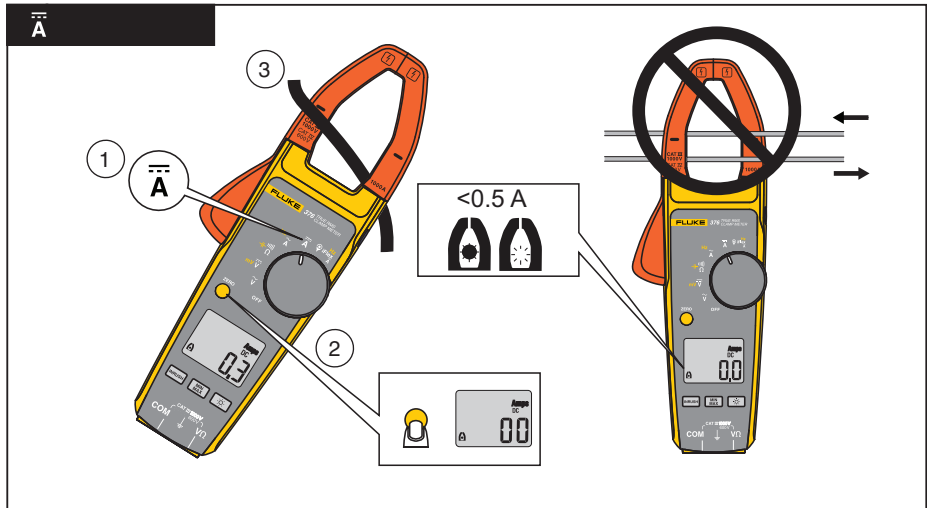

Fig08.eps

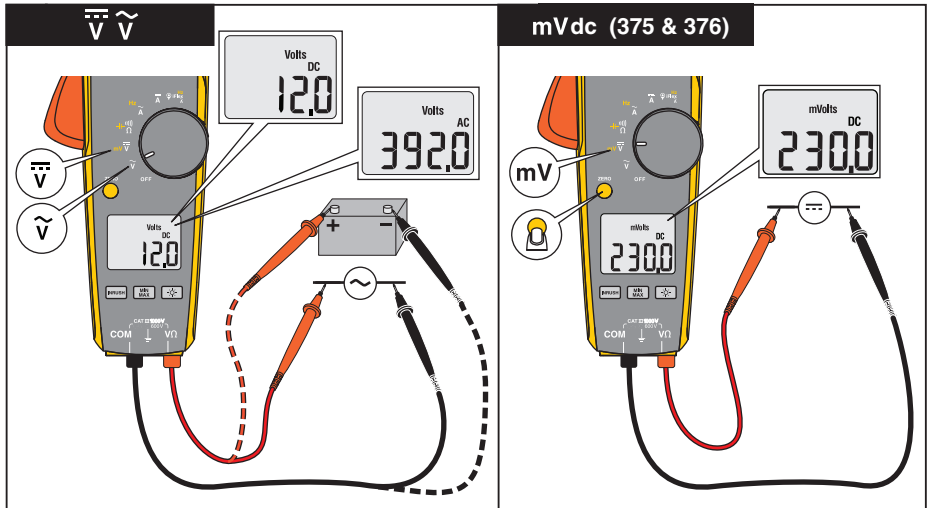

fig09_10.eps

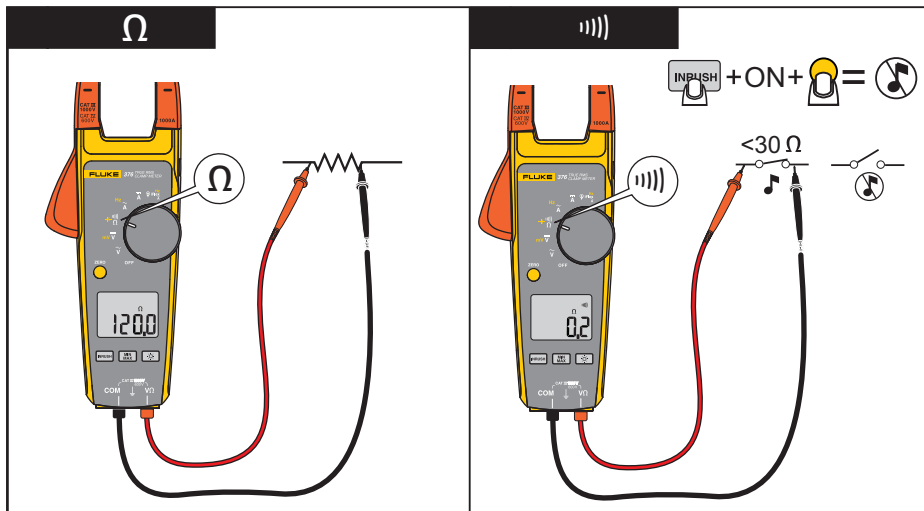

Fig15.eps

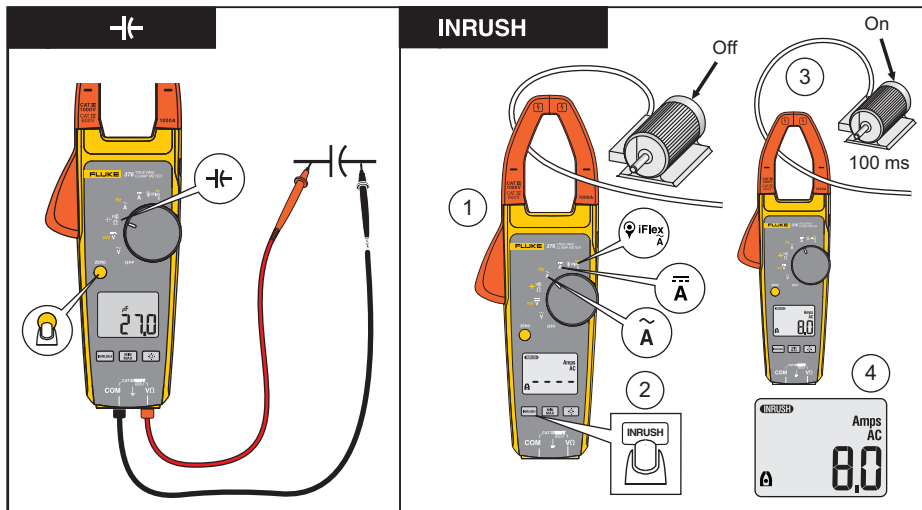

fig13_14.eps

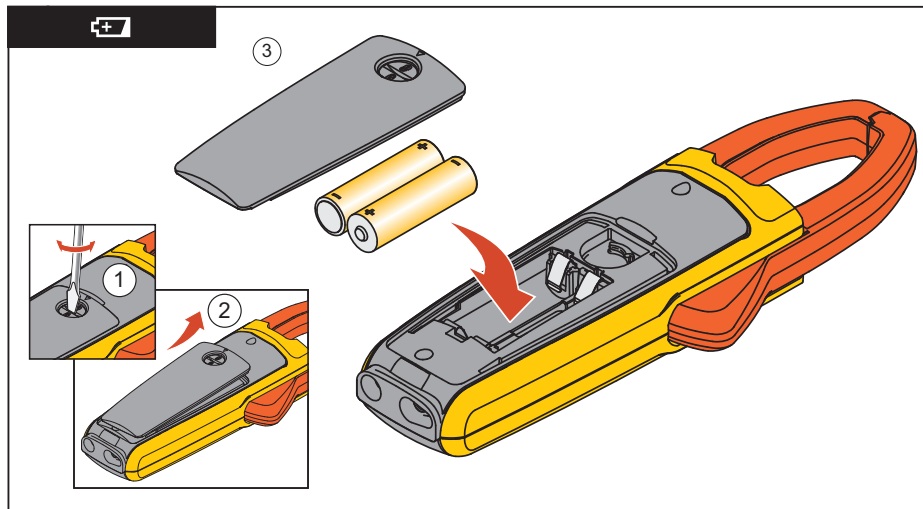

fig11_12.eps

Specifications

Electrical Specifications

AC Current via Jaw

Range

374 and 375 600.0 A

376..... 999.9 A

Resolution 0.1 A

Accuracy 2 % \pm 5 digits (10-100 Hz)

2.5 % \pm 5 digits (100-500 Hz)

Crest Factor (50/60 Hz) 3 @ 500 A (375 and 376 only)

2.5 @ 600 A

1.42 @ 1000 A (376 only)

Add 2 % for C.F. > 2

AC Current via Flexible Current Probe

Range	2500 A
Resolution	
374 and 375	0.1 A (≤ 600 A)
	1 A (≤ 2500 A)
376	0.1 A (≤ 999.9 A)
	1 A (≤ 2500 A)
Accuracy	3 % ± 5 digits (5 – 500 Hz)
Crest Factor (50/60Hz)	3.0 at 1100 A (375 and 376 only)
	2.5 at 1400 A
	1.42 at 2500 A
	Add 2 % for C.F. > 2

Position Sensitivity

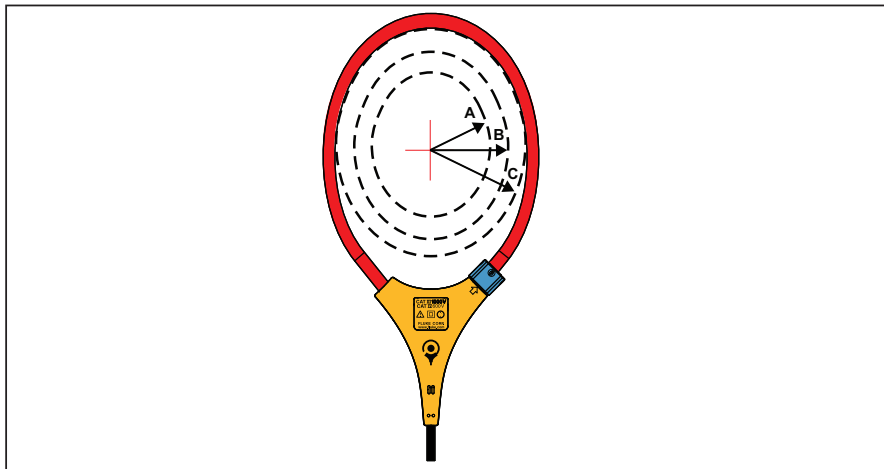

ghn12.eps

Figure 1. Position Sensitivity

374, 375, 376
Users Manual

Distance from Optimum	i2500-10 Flex	i2500-18 Flex	Error
A	0.5 in (12.7 mm)	1.4 in (35.6 mm)	± 0.5 %
B	0.8 in (20.3 mm)	2.0 in (50.8 mm)	± 1.0 %
C	1.4 in (35.6 mm)	2.5 in (63.5 mm)	± 2.0 %

Measurement uncertainty assumes centralized primary conductor at optimum position, no external electrical or magnetic field, and within operating temperature range.

DC Current

Range

374 and 375 600.0 A

376..... 999.9 A

Resolution 0.1 A

Accuracy 2 % ± 5 digits

AC Voltage

Range

374 and 375 600.0 V

376 1000 V

Resolution

374 and 375 0.1 V

376 0.1 V (≤ 600.0 V)

1 V (≤ 1000 V)

Accuracy 1.5 % \pm 5 digits (20 – 500 Hz)

DC Voltage

Range

374 and 375 600.0 V

376 1000 V

374, 375, 376

Users Manual

Resolution

374 and 375	0.1 V
376	0.1 V (≤ 600.0 V)
	1 V (≤ 1000 V)

Accuracy 1 % \pm 5 digits

mV dc

Range

375 and 376..... 500.0 mV

Resolution..... 0.1 mV

Accuracy 1 % \pm 5 digits

Frequency via Jaw

Range

375 and 376..... 5.0 - 500.0 Hz

Resolution..... 0.1 Hz

Accuracy 0.5 % \pm 5 digits

Trigger Level	5 – 10 Hz, ≥ 10 A
	10 – 100 Hz, ≥ 5 A
	100 – 500 Hz, ≥ 10 A

Frequency via Flexible Current Probe

Range

375 and 376	5.0 – 500.0 Hz
Resolution	0.1 Hz
Accuracy	0.5 % \pm 5 digits
Trigger Level	5 – 20 Hz, ≥ 25 A
	20 – 100 Hz, ≥ 20 A
	100 – 500 Hz, ≥ 25 A

Resistance

Range

374.....	6000 Ω
375 and 376.....	60 k Ω

Resolution

374..... 0.1 Ω (\leq 600 Ω)

1 Ω (\leq 6000 Ω)

375 and 376..... 0.1 Ω (\leq 600 Ω)

1 Ω (\leq 6000 Ω)

10 Ω (\leq 60 k Ω)

Accuracy 1 % \pm 5 digits

Capacitance

Range 1000 μ F

Resolution..... 0.1 μ F (\leq 100 μ F)

1 μ F (\leq 1000 μ F)

Accuracy 1 % \pm 4 digits

Mechanical Specifications

Size (L x W x H) 246 mm x 83 mm x 43 mm

Weight..... 388 g

Jaw Opening..... 34 mm

Flexible Current Probe Diameter 7.5 mm

Flexible Current Probe Cable Length

(head to electronics connector)..... 1.8 m

Environmental Specifications

Operating Temperature..... -10 °C – +50 °C

Storage Temp -40 °C – +60 °C

Operating Humidity Non condensing (< 10 – °C)
≤ 90 % RH (at 10 °C – 30 °C)
≤ 75 % RH (at 30 °C – 40 °C)
≤ 45 % RH (at 40 °C – 50 °C)

Operating Altitude 3000 meters

Storage Altitude 12,000 meters

EMC EN 61326-1:2006

Temperature Coefficients..... Add 0.1 x specified accuracy for each degree C above
28 °C or below 18 °C

Safety Specifications

Safety Compliance..... CAN/CSA-C22.2 No. 61010-1-04
ANSI/UL 61010-1:2004
ANSI/ISA-61010-1 (82.02.01):2004
EN/IEC 61010-1:2001 to
1000V Measurement Category (CAT) III
600V Measurement Category (CAT) IV
Pollution Degree 2
EN/IEC 61010-2-032:2002
EN/IEC 61010-031:2002+A1:2008



Agency Approvals.....



Batteries..... 2 AA, NEDA 15A, IEC LR6