

Instruction Manual



High Voltage Digital Insulation Tester

KEW 3128



**KYORITSU ELECTRICAL
INSTRUMENTS WORKS, LTD.**

Contents

Contents	2
1. Safety Warnings	4
2. Feature	7
3. Specification	9
4. Instrument Layout	16
4. 1 FRONT VIEW	16
4. 2 SIDE PANEL	18
4. 3 TEST LEADS	19
4. 4 HARD CASE	19
5. Preparation for Measurement	20
5. 1 CHECKING THE BATTERY VOLTAGE	20
5. 2 TEST LEAD CONNECTION	20
6. Measurement	21
6. 1 BASIC OPERATION	21
6.1.1 How to start measurements	21
6.1.2 Steps for Measurements	23
6.1.3 Setting for Measurement	30
6.1.4 Graph Operation	33
6.1.5 Menu	37
6.1.6 Filter Mode	41
6.1.7 Save Data	42
6.1.8 Clock Setting	47
6.1.9 Demo Mode	47
6. 2 INSULATION DIAGNOSIS TESTS	48
6. 3  IR MEASUREMENT	49
6.3.1 Setting Item	49
6.3.2 Measured Result	49
6. 4  PI MEASUREMENT (POLARIZATION INDEX)	50
6.4.1 Polarization Index	50
6.4.2 How to measure PI	50

6.4.3 Measured Result	53
6. 5 DAR DAR MEASUREMENT (DIELECTRIC ABSORPTION RATIO)	54
6.5.1 Dielectric Absorption Ratio	54
6.5.2 How to measure DAR	55
6.5.3 Measured Result	57
6. 6 DD DD MEASUREMENT (DIELECTRIC DISCHARGE)	58
6.6.1 Dielectric Discharge	58
6.6.2 How to measure DD	59
6.6.3 Measured Result	61
6. 7 SV SV MEASUREMENT (STEP VOLTAGE)	62
6.7.1 Step Voltage	62
6.7.2 Measurement Setting Items	62
6.7.3 Measured Result	64
6. 8 MEASUREMENT SCREEN	65
6. 9 CAPACITANCE MEASUREMENT	68
6.9.1 Measurement Screen	68
6. 10 Vtest VOLTAGE MEASUREMENT	69
6.10.1 Measurement Screen	69
6. 11 OTHER FUNCTIONS	70
6.11.1 Use of Guard Terminal	70
6.11.2 Backlight Function	71
6.11.3 Auto-power-off function	71
7. Battery Charging and Replacement	72
7. 1 HOW TO CHARGE BATTERY	72
7. 2 HOW TO REPLACE BATTERY	73
8. Communication Function/ Supplied Software	75
8. 1 HOW TO INSTALL THE SOFTWARE	76
8. 2 HOW TO START “KEW WINDOWS FOR KEW3128”	80
9. Accessories	81
9. 1 METAL PARTS FOR LINE PROBE, AND REPLACEMENT	81
10. Disposing the Product	82

1. Safety Warnings



- This instrument has been designed, manufactured and tested according to IEC 61010: Safety requirements for Electronic Measuring apparatus, and delivered in the best condition after passing quality control tests. This instruction manual contains warnings and safety rules which have to be observed by the user to ensure safe operation of the instrument and to maintain it in safe condition. Therefore, read through these operating instructions before using the instrument.

WARNING

- This instrument outputs high voltages. Read through and understand the instructions contained in this manual before using the instrument.
- Keep the manual at hand to enable quick reference whenever necessary.
- The instrument is to be used only in its intended applications.
- Understand and follow all the safety instructions contained in the manual.

It is essential that the above instructions are adhered to.

Failure to follow the above instructions may cause injury, instrument damage and/or damage to equipment under test.

- The symbol  indicated on the instrument, means that the user must refer to the related parts in the manual for safe operation of the instrument. It is essential to read the instructions wherever the  symbol appears in the manual.

 **DANGER** : is reserved for conditions and actions that are likely to cause serious or fatal injury.

 **WARNING** : is reserved for conditions and actions that can cause serious or fatal injury.

 **CAUTION** : is reserved for conditions and actions that can cause injury or instrument damage.

⚠ DANGER

- Put a pair of insulated gloves and use this instrument.
- Never make measurement on a circuit in which the electrical potential exceeds AC/DC600V.
- Do not attempt to make measurement in the presence of flammable gasses. Otherwise, the use of the instrument may cause sparking, which can lead to an explosion.
- Never attempt to use the instrument if its surface or your hand are wet.
- Be careful not to short-circuit the power line with the metal part of the test leads when measuring voltage. It may cause personal injury.
- Do not exceed the maximum allowable input of any measuring range.
- Do not press the Test Button without test leads connected to the instrument.
- Never open the Battery Compartment Cover while making measurement.
- Do not touch the circuit under test when measuring insulation resistance or right after a measurement. You may get an electric shock by a test voltage.
- Stop a measurement if contamination or carbonization which may impair insulation characteristics is found on the test leads or around the terminals.
- Do not repeat short-circuiting/ opening of test leads intentionally during insulation resistance measurements. Otherwise, measurements may be ceased or LCD may become blank due to a malfunction of the instrument. Aerial discharges occur at the tips of test leads when short-circuiting and opening the test leads; excessive discharges may impair the performance of the instrument.







⚠ WARNING

- Never attempt to make any measurement if any abnormal conditions are noted, such as broken case and exposed metal parts.
- Do not rotate the Range Switch with the test leads connected to the equipment under test.
- Do not install substitute parts or make any modification to the instrument. Return the instrument to Kyoritsu or your distributor for repair or re-calibration.
- Do not try to replace battery if the surface of the instrument is wet.
- Be sure to insert the plug into the terminal firmly when using test leads.
- Make sure to power off the instrument when opening the Battery Compartment Cover for battery replacement.

⚠ CAUTION

- Always make sure to set the Range Switch to the appropriate position before making measurement.
- Be sure to set the Range Switch to the “OFF” position after use and remove the test leads. When the instrument will not be in use for a long period, place it in storage after removing the battery. Instructions how to remove a battery are described at Clause 7. Battery Charging and replacement (=>P.72).
- Do not expose the instrument to the direct sun, high temperature and humidity or dewfall.
- Use a cloth dipped in water or neutral detergent for cleaning the instrument. Do not use abrasives or solvents.
- When this instrument is wet, please store it after it dries.
- Remove a battery from the instrument and pack it carefully at the time of transportation.

Symbol

	Danger of possible electric shock
	Instrument with double or reinforced insulation
	DC
	AC
	Earth terminal
	Must refer to the Instruction Manual to protect humans and devices
CAT. IV	The circuit from the service drop to the service entrance, and to the power meter and primary overcurrent protection device (distribution panel)

2. Feature

KEW3128 is a digital high voltage insulation resistance tester with 6-range: 500V, 1000V, 2500V, 5000V, 10000V and 12000V, and can measure up to 35T Ω . Fine adjustment of voltage setting at each Range is available. Measured results can be saved in the internal memory; they can be transferred to a PC via a special USB cord. Measuring data can also be transferred to a PC in real-time.

- Designed to meet following safety standards:
IEC 61010-1 CAT.IV 600V

- Insulation Resistance Measurement
Test Voltage 12kV (max), Resistance 35T Ω (max),
Short-Circuit Current 5mA (max)

- Insulation Diagnosis Tests
Values of Polarization Index (PI), Dielectric Absorption Ratio (DAR) and Dielectric Discharge (DD) are displayed automatically, and measurements of Step Voltage (SV), Leakage Current and Capacitance can be performed.
* Further details of Insulation Diagnosis Test is described in clause 6. 2 (=>P.48).

- Saving the Measured Data
The internal memory can store 32 files (max).
Use of Print Screen Function enables save of screenshots.

- Dual Power Supply
Lead storage battery (12V, 5Ah) should be used for KEW3128. In the event of interruption, while operating with AC power supply, power to the instrument is automatically restored by the battery in the instrument.

- **Large Display**
5.7-inch (320 x 240 dots)

- **Graph Display**
Variations in insulation resistances and leakage currents under measurements are displayed as graphs.
When a measurement period exceeds 90 min (IR measurement only), 90min or later portion of the measured result isn't displayed on a graph.

- **Application**
Data in the internal memory or measuring in real-time can be transferred to a PC via a special USB adapter. The supplied software facilitates setting of the instrument and data analysis.

- **Live Circuit Warning**
LIVE circuit warning symbols plus audible warning

- **Auto Discharge Function**
When insulation resistance like a capacitive load is measured, electric charges stored in capacitive circuits are automatically discharged after measuring. Discharge can be checked with a voltage monitor.

- **Backlight Function**
Backlight function to facilitate working at dimly illuminated location or at nighttime work.

- **Auto-Power-Off Function**
To prevent the instrument being left powered on and conserve battery power, the instrument automatically turns off approx. 10 min after the last switch operation.

- **Filter Function**
KEW3128 provides 3 kinds of Filter functions to alleviate fluctuations in readings. Details of Filter function are described at 6.1.6 Filter Mode (=> P.41).

3. Specification

● Applicable Standards:

IEC61010-1	CAT.IV 600V Pollution Degree2
IEC61010-031	For Hand-held Probe Assemblies
IEC61326	EMC Standard for electrical equipment for measurement, control and laboratory use
IEC60529	IP64 (with the Bottom Case closed)
CISPR22, 24	

● Measuring Range and Accuracy (under 23±5°C and 45 – 75%RH)

【Insulation Resistance Tester】

Rated Voltage	500V	1000V	2500V	5000V	10000V	12000V	
Max value	500G Ω	1.00T Ω	2.50T Ω	5.00T Ω	35.0T Ω	35.0T Ω	
Accuracy	400k to 50G Ω ±5%rdg±3dgt 50G to 500G Ω ±20%rdg *Accuracy is not guaranteed with setting of 250V or less.	800k to 100G Ω ±5%rdg±3dgt 100G to 1T Ω ±20%rdg	2M to 250G Ω ±5%rdg±3dgt 250G to 2.5T Ω ±20%rdg	4M to 500G Ω ±5%rdg±3dgt 500G to 5T Ω ±20%rdg	8M to 1T Ω ±5%rdg±3dgt 1T to 10T Ω ±20%rdg 10T to 35T Ω Values are displayed, but accuracy isn't guaranteed.	8M to 1T Ω ±5%rdg±3dgt 1T to 10T Ω ±20%rdg 10T to 35T Ω Values are displayed, but accuracy isn't guaranteed.	
Display Range	400k to 999k 1.00M to 9.99M 10.0M to 99.9M 100M to 999M 1.00G to 9.99G 10.0G to 99.9G 100G to 600G	800k to 999k 1.00M to 9.99M 10.0M to 99.9M 100M to 999M 1.00G to 9.99G 10.0G to 99.9G 100G to 999G 1.00T to 1.20T	2.00M to 9.99M 10.0M to 99.9M 100M to 999M 1.00G to 9.99G 10.0G to 99.9G 100G to 999G 1.00T to 3.00T	4.00M to 9.99M 10.0M to 99.9M 100M to 999M 1.00G to 9.99G 10.0G to 99.9G 100G to 999G 1.00T to 6.00T	8.00M to 9.99M 10.0M to 99.9M 100M to 999M 1.00G to 9.99G 10.0G to 99.9G 100G to 999G 1.00T to 9.99T 10.0T to 35.0T	8.00M to 9.99M 10.0M to 99.9M 100M to 999M 1.00G to 9.99G 10.0G to 99.9G 100G to 999G 1.00T to 9.99T 10.0T to 35.0T	
Out-of-range display	Lower limit	<400k Ω <1.8mA	<800k Ω <1.65mA	<2.00M Ω <1.65mA	<4.00M Ω <1.65mA	<8.00M Ω <0.263mA	<8.00M Ω <0.315mA
	Upper limit	>600G Ω	>1.20T Ω	>3.00T Ω	>6.00T Ω	>35.0T Ω	>35.0T Ω
Short-circuit current	Max 5.0mA						
Leakage current	0.01nA ~						
Output current	1mA or more, 1.2mA or less under a load of 0.5M Ω *Should be 500V or more	1mA or more, 1.2mA or less under a load of 1M Ω	1mA or more, 1.2mA or less under a load of 2.5M Ω	1mA or more, 1.2mA or less under a load of 5M Ω	0.15mA or more, 0.25mA or less under a load of 10M Ω	0.15mA or more, 0.25mA or less under a load of 12M Ω	

Note: The Lower limit value within the Display Range is shown when the test leads are short-circuited and the Upper limit value within the Display Range is shown when measured values exceeds the Display Range.

【Output Voltage】

Rated Voltage	500V	1000V	2500V	5000V	10000V	12000V
Monitor Accuracy	$\pm 10\% \text{rdg} \pm 20\text{V}$	$\pm 10\% \text{rdg} \pm 20\text{V}$	$\pm 10\% \text{rdg} \pm 20\text{V}$	$\pm 10\% \text{rdg} \pm 20\text{V}$	$\pm 10\% \text{rdg} \pm 20\text{V}$	$\pm 10\% \text{rdg} \pm 20\text{V}$
Output Accuracy	0~+20%	0~+10%	0~+10%	0~+10%	-5~+5%	-5~+5%
Selectable Range	50~600V (in steps of 5V)	610~1200V (in steps of 10V)	1225~3000V (in steps of 25V)	3050~6000V (in steps of 50V)	6100~10000V (in steps of 100V)	10100~12000V (in steps of 100V)

Incorrect readings are displayed when external AC voltages are applied.

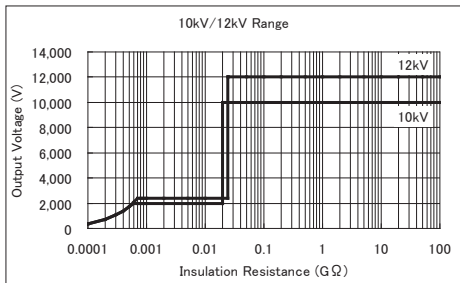
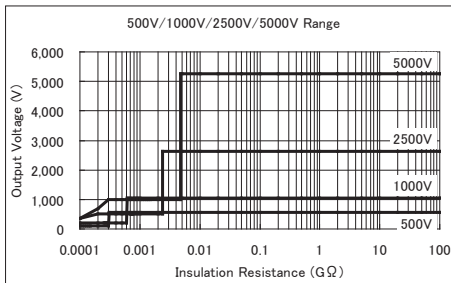
【Graph of Resistance-Output voltage Characteristic】

Rated current at 500V, 1000V, 2500V, 5000V Ranges : max 1mA or higher

Rated current at 10kV, 12kV Ranges : max 0.5mA

Above graphs show the relations between output voltages and measurement resistances.

【Volt Meter】

Range	Voltage Test	
Measuring Range	DC Voltage	AC Voltage
	$\pm 30 \sim \pm 600V$	30~600V(50/60Hz)
Accuracy	$\pm 2\%rdg \pm 3dgt$	

【Frequency】

Range	Voltage Test
Measuring Range	45.0 ~ 65.0Hz
Accuracy	$\pm 0.2Hz$

【Ammeter】

Measuring Range	0.00nA ~ 2.40mA Minimum resolution 0.01nA (determined by resistance and voltage values)	Depending on the effective range of insulation resistances
-----------------	--	--

* The output current can throw 5mA. The current that flows by the lower bound within the range of the resistance measurement is shown in the table **【Insulation Resistance Tester】** of page 10.

When resistance that is lower than the lower bound within the range of the resistance measurement is measured, the measurement current might become larger than 2.4mA.

The display in that case becomes ">2.40mA".

【Capacity Meter】

Range	500V ~ 5000V Range	10000V / 12000V Range
Accuracy	5.0nF ~ 50.0 μ F	5.0nF ~ 1.0 μ F
	$\pm 5\%rdg \pm 5dgt$	

* Measurements of capacitance of 0.5 μ or more shouldn't be repeated at 10000V/ 12000V Ranges in a short time. (Rough guide: 5 times/ hour)

* A message "Noise Error" may be displayed on the LCD and a measurement may be ceased at 10000/12000V Ranges. In this case, select a lower Voltage Range and test again.

【Calculated Value】

PI,DAR,DD

Measurement Mode	PI	DAR	DD
Display Range	0.00 ~ 999	0.00 ~ 999	0.00 ~ 999
Computational error	$\pm 2dgt$	$\pm 2dgt$	$\pm 2dgt$

● Electromagnetic compatibility (IEC61000-4-3)

Radio-frequency electromagnetic field

= 10V/m : 20times of the specified accuracy

● Operating system	Dual integration
● Display	320 x 240 dots, 5.7-inch Monochrome Display
● Low battery warning	Battery mark display (in 4 levels)
● Response time	approx 30 sec in a range of $\pm 5\%$ of accuracy approx 60 sec in a range of $\pm 20\%$ of accuracy (Response time becomes slower when output voltage becomes lower.)
● Auto-power-off	Power-off function operates when 10 min pass without any key operation.
● Altitude	2000m or less
● Temperature & humidity range(guaranteed accuracy)	23°C \pm 5°C/Relative humidity 85% or less (no condensation)
● Operating temperature & humidity range	-10°C~50°C/Relative humidity 85% or less (when operating with an external power supply, no condensation) 0°C~40°C/Relative humidity 85% or less (when operating with battery, no condensation)
● Storage temperature & humidity range	-20°C~60°C/Relative humidity 75% or less (no condensation)
● Overload protection	AC720V/10 sec.
● Withstand voltage	AC8770V : between line terminal and enclosure /5sec (50/60Hz) AC6880V : between the measuring terminal and enclosure /5sec (50/60Hz) AC2330V : between the power connector and enclosure /5sec (50/60Hz)
● Insulation resistance	1000M Ω or more/DC1000 V (between electrical circuit and enclosure)
● Dimension	330(L) \times 410(W) \times 180(D)mm (Instrument and Hard case)
● Weight	approx 9kg (including battery) (Instrument and Hard case)
● Power source	Rechargeable Lead storage battery (PXL-12050:12V 5Ah), AC Power supply (100V ~ 240V, 50 / 60Hz)

● Current Consumption (representative values at 12V of battery voltage)

Range	500V	1000V
Short-circuiting the output	2650mA	2300mA
Short-circuiting the output of rated current	1350mA/0.5M Ω	1500mA/1M Ω
Opening the output	210mA	220mA

Range	2500V	5000V
Short-circuiting the output	1700mA	1600mA
Short-circuiting the output of rated current	1650mA/2.5M Ω	2000mA/5M Ω
Opening the output	280mA	380mA

Range	10000V	12000V
Short-circuiting the output	1550mA	1550mA
Short-circuiting the output of rated current	500mA/10M Ω	540mA/12M Ω
Opening the output	570mA	650mA

Range	Voltage Test
Measuring voltages	210mA

Range	All Ranges
On Stand-by	210mA
Backlight is On	Increased by 80mA

- Continuous measurement: No limitation (IR measurement mode)
 - * recorded data and graph are max 90 min.
 - Max 90 min (SV measurement mode)
 - Max 60 min (PI/DAR/DD measurement mode)
- Max current consumption and measurement time while rated currents are maintained.

Condition	Current consumption	Measurement time
500V / 300k Ω	2100mA or less	Approx 2 hours
1000V / 600k Ω		
2500V / 2.4M Ω		
5000V / 4.8M Ω		
10000V / 20M Ω		
12000V / 24M Ω		

* Current consumption may exceed above values when low resistances, which influence the output of rated currents, are measured.

* Measurement time (approx 4 hours) described at page 15 and the Measurement time in above table are the periods that full-charged battery voltage drops to the lowest level

* It is recommended to charge the battery with reference to “7.1 How to charge battery” described in the manual before stating to use with the instrument since the battery voltage may be low due to self-discharge.

- Accessories
 - Line Probe (MODEL7226)
 - Line Probe with Alligator Clip (MODEL7227)
 - Earth Cord (MODEL7224)
 - Guard Cord (MODEL7225)
 - Communication Adapter (MODEL8212 USB)
 - PC Software
 - Straight Type Metal Parts (MODEL8029)
 - Power Cord (MODEL7170)
 - Instruction Manual

4. Instrument Layout

4.1 Front View

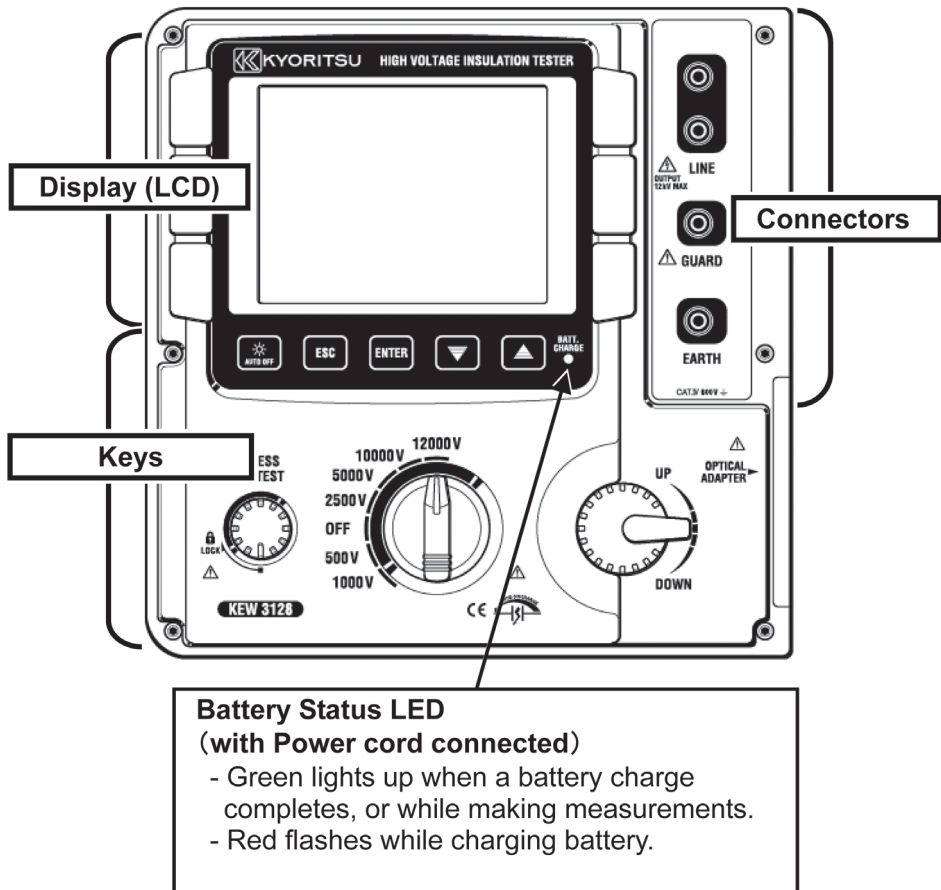

Keys

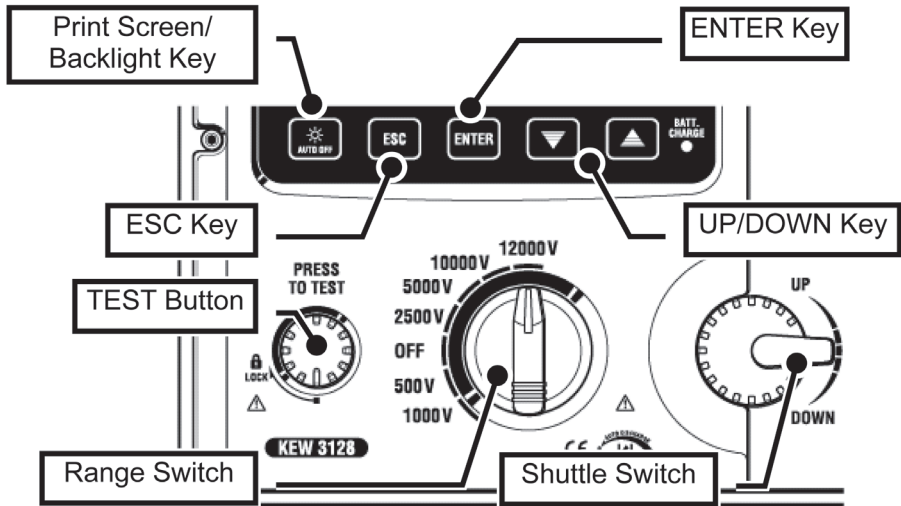

Keys	Details
Print Screen/Backlight Key	Short press : Turn on/ off the LCD Backlight Long press : Save the displayed screen as a (1sec or longer) BMP (bitmap) file.
ESC Key	Cancel a process, or return to the previous screen.
ENTER Key	Confirm entries, or move to the next screen.
UP/DOWN Key	Move a cursor or alter setting values.
TEST Button	Start measurements.
Range Switch	Power on/off the instrument, or select a Measurement Range.
Shuttle Switch	Move a cursor or alter setting values.

Connectors

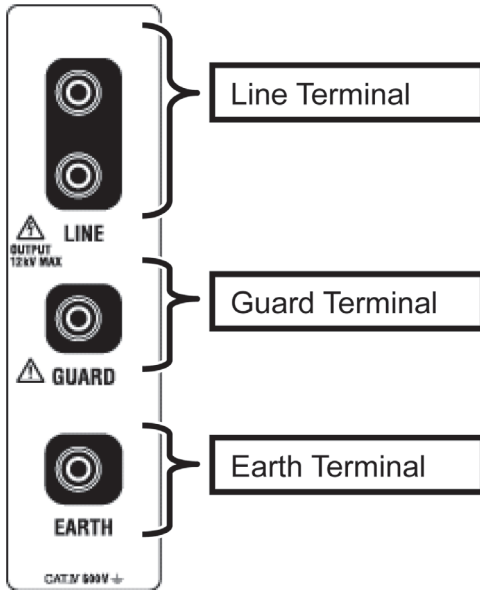

4.2 Side Panel

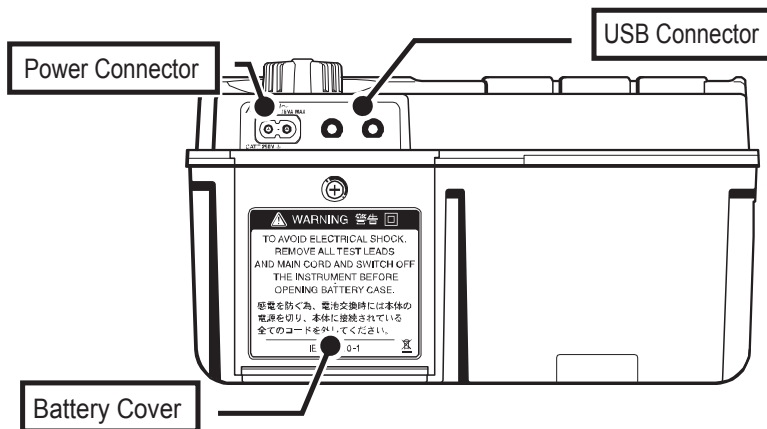

4.3 Test Leads

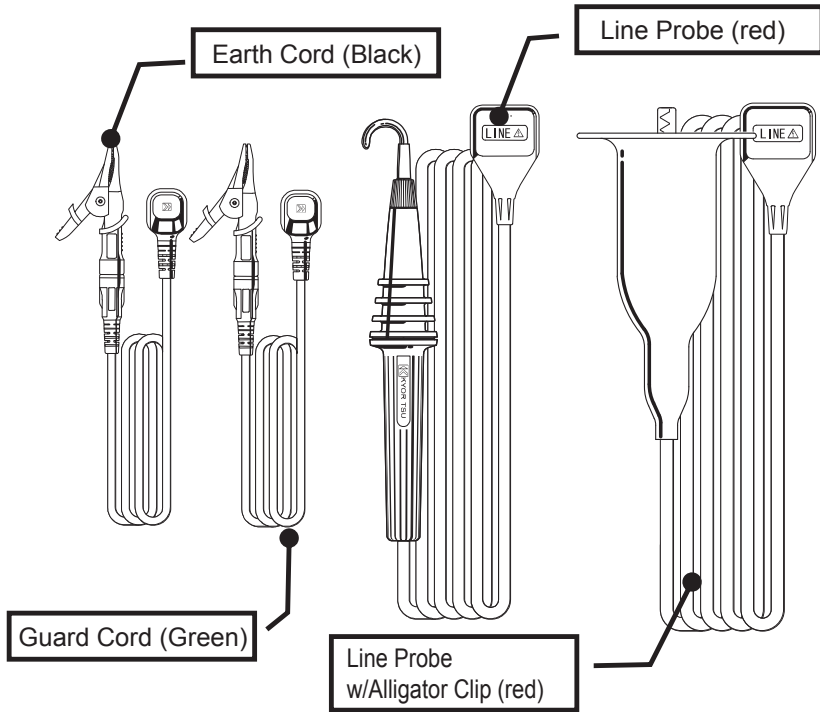

Depending on usage, either Line Probe or Line Probe with Alligator Clip is connected to the Line terminal.

4.4 Hard Case

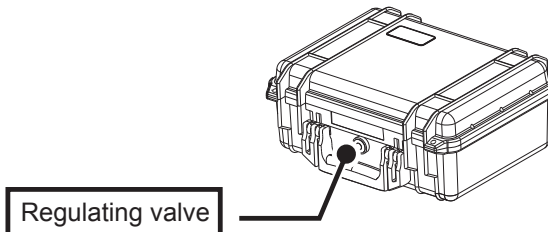

Regulating valve is to balance the air pressure in the Case hermetically sealed and external atmosphere for easy opening/closing of Case lid. Do not force to turn it or remove it.

5. Preparation for Measurement

5.1 Checking the battery voltage

Set the Range Switch to any position other than “OFF” without connecting the Power Cord to the Power Connector.

When the Battery Mark shown at the upper right on the LCD is last 1 level (), the battery is almost exhausted. Replace or recharge battery to continue measurements. The instrument operates properly even if under such a low battery, and such a low battery status may not affect the accuracy.

When the Battery Mark is vacant (), the battery voltage is below the lower limit of the operating voltage. So the accuracy cannot be guaranteed.

No measurement can be performed even the TEST Button is pressed down. Refer to Battery Charge and Replacement (=>P.72) and charge or replace battery.

5.2 Test Lead Connection

Insert the test lead firmly to the Connector Terminal on the instrument.

Connect the Line Probe (red) or Line Probe with Alligator clip (red) to the Line Terminal, Earth Cord(black) to the Earth Terminal and Guard Cord(green) to Guard Terminal. No need to connect Guard Cord when establishing a guard is not necessary.

Refer to “**How to use Guard Terminal**” (=>P.70) in this manual for further details.

DANGER

- If the TEST Button is pressed while the Range Switch is at a Range other than “OFF”, high voltages may applied to the test leads and you may get an electric shock.
- Do not connect the Earth Cord (black) nor Guard Cord (green) to the Line Terminal.

Carefully read through “1. Safety Warnings” (P.4) in this manual.

6. Measurement

6.1 Basic Operation

6.1.1 How to start measurements

Start-up Screen

Setting the Range Switch to any position other than the OFF position powers on the instrument. Setting the Switch to the OFF position powers off the instrument.

Following Start-up Screen with Model name and Version info is displayed when powering on the instrument. Then KEW logo will appear.

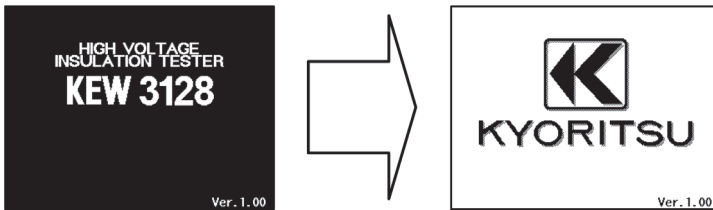

* Pressing the Enter Key skips the opening screen.

The Mode Selection Screen appears at the initial operation after purchase.

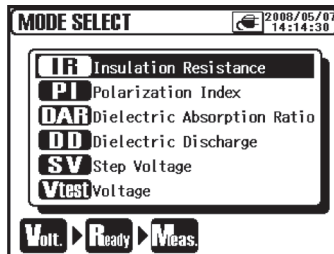

The instrument remembers the previous selected mode, and starts with the mode next time it is powered on.

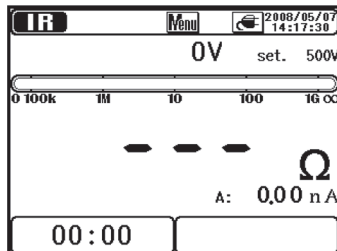

How to select a Measurement Mode

A long press (1 sec or more) of the **ESC Key** displays the Mode Selection Screen.

Measurement modes which are selectable on the Model Selection Screen are mentioned at “Insulation Diagnosis test” (=>P.48).

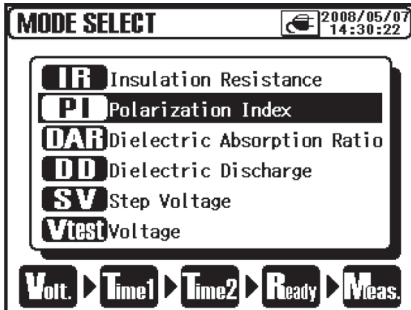

Move the cursor with the **UP/ DOWN Key** or **Shuttle Switch**, and confirm the mode with the **ENTER Key**.

Then a process from making settings to a start of measurement is displayed at the bottom of the LCD. Measurement Modes can be switched directly from the Menu.

(=>P.37 Menu)

6.1.2 Steps for Measurements

Insulation Resistance Measurement

- ① Check the voltage which can be applied to the circuit under test, and set the Range Switch to any desired Voltage Range.
- ② Select the "IR" (Insulation Resistance) on the Mode Selection Screen, and press the ENTER Key.

The instrument gets started with the previously selected mode, and enters into the stand-by mode.

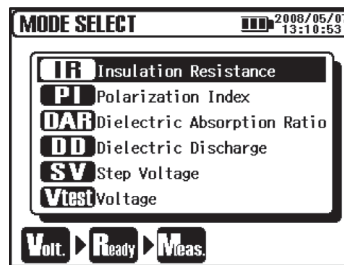

- ③ Set a voltage value, and confirm it with the ENTER Key.

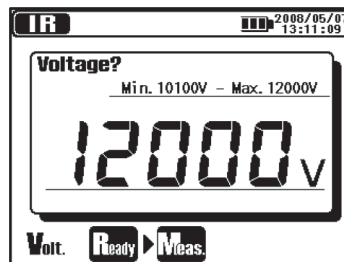

- ④ Confirmation Screen is displayed. Press the ENTER Key and confirm the value.

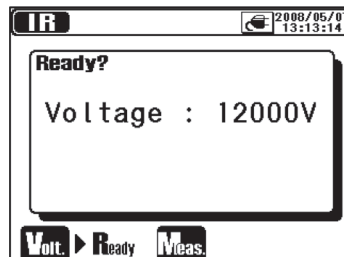

- ⑤ The instrument enters into stand-by mode when settings are made.

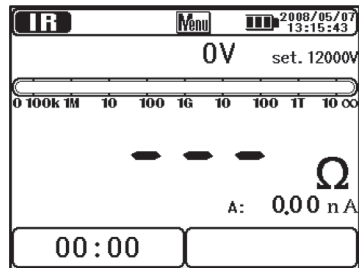

- ⑥ Connect the Earth Cord (black) to the Earth Terminal of the circuit under test.

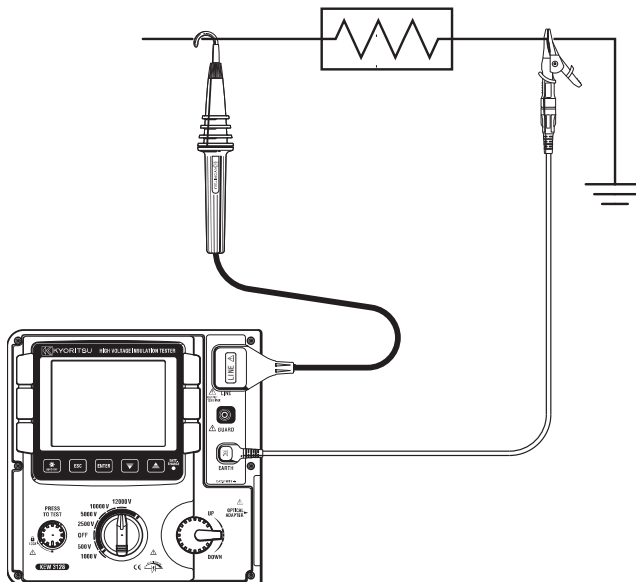

- ⑦ Put the tip of the Line Probe (red) to the circuit under test. Then press the Test Button. The buzzer sounds intermittently during a measurement.

Press and turn the Test Button clockwise to lock the Button for making measurements continuously.

The sound of buzzer when a Voltage Range is set to 12kV is special to give warnings that high voltages more than 10kV is output.

- ⑧ The measured value will be displayed on the LCD.

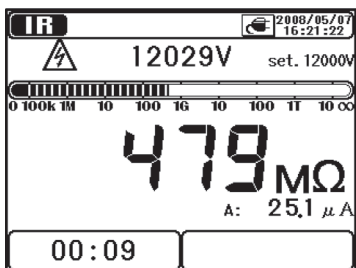

- ⑨ Release the Button to stop the measurement. Then the measured results will be displayed on the LCD.

Turn the locked Test Button counterclockwise and unlock the Button.

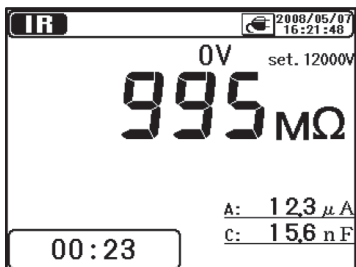

- ⑩ This instrument has an auto-discharge function. With the test leads connected to the circuit under test, release the Test button to discharge capacitance in the circuit after test.

Confirm that the readings on the Voltage monitor becomes "0V".

* Do not remove the test leads if the discharging process is not finished. In case of disconnection of test leads before the finish the discharging process, reconnect the test leads to the measured object again and continue the discharge. In this case, a longer discharge period is required because the internal discharge circuit doesn't work. Attention should be paid when reconnecting the test leads in order to limit the possible aerial discharges.

- ⑪ Set the Range Switch to "OFF" position, and remove the test leads from the device under test.

Next measurement may not be started when the Test Button is pressed right after when above step 10 is done. In this case, release the Test Button and wait for a few seconds, and then press the Test Button.

Refer to "**IR** IR Measurement" (=>P.49) and subsequent pages about the further details of items displayed at each Measurement mode.

⚠ DANGER

- Do not touch the circuit under test just after finishing a measurement. The charged potentials may cause electrical shock hazard.
- Do not touch the circuit under test and also not to remove the test leads until a discharge completes.
- Check with a High Voltage Detector that there is no electrical charge exists on the circuit under test.
- Be sure to put on a pair of insulated gloves for high voltage.
- Be extremely careful not to get electric shock during insulation resistance measurements and the Test Button is being pressed as high voltage is present on the tip of test leads and on the circuit under test continuously.
- Do not make measurement with the Battery Cover removed.
- Do not make measurement when thunder rumbling.

⚠ CAUTION

- When the live circuit warning is indicated or the warning buzzer sounds, measurements cannot be made even if the Test Button is pressed.

To check the insulation of electric equipments or electric circuits, measure their insulation resistances with this instrument. Be sure to check the voltage which can be applied to the equipment under test before making a measurement.

Measurements automatically stop, when battery voltage becomes too low to ensure accuracy of readings, while the instrument is operating with a battery. In this case, the instrument performs auto-discharge and displays warning for low battery voltage as shown below. Then LCD becomes blank.



Note:

- * Insulation resistance values of the equipment under test may not be stable, and the readings on the LCD may be unstable.
- * Oscillation sound may be heard during insulation resistance measurement, but it is not malfunction.
- * It takes time to measure a capacitive load.
- * Measurements, right after a measurement complete, may not get started even the Test Button is pressed. In such a case, press the Button in several seconds later.
- * For insulation resistance measurements, normally the output voltage generated by the instrument is in DC, with the positive pole (+) connected to the earth terminal of the instrument and the negative pole (-) to the line terminal of the instrument.
With objects under test connected to earth (ground), the voltage applied by instrument with such polarity, usually permits to read smaller measured values (so better for safety) comparing with other way round polarity.
- * Do not extend and use the test leads; it may affect on measurement accuracy or impair the safety of this instrument.
- * When measuring high resistance higher than $1T\Omega$, the Part A of the Line Probe indicated in the below illustration shouldn't be touched with the things other than the measured object. In case that such a contact is unavoidable, use something with high insulation resistance like Teflon or foamed polystyrene, as a cushion.

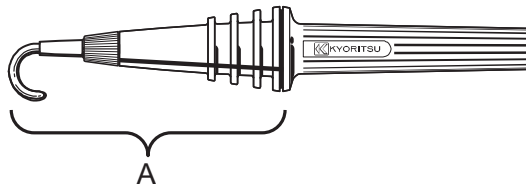

- * When making measurements without connecting the test leads to anything to be tested, an over-range indication, e.g. “ $>35.0T\Omega$ ” (at 10kV or 12kV Range), may not be displayed.
It is likely caused in high humidity environment due to currents leaked at unexpected points other than the measured objects due to applying high voltages.
- * Proper measurements cannot be made due to influences of variations in strong magnetic fields or noises caused at discharging energies stored in

capacitors or something like this when short-circuiting/ opening the Line – Earth (Guard) of the test lead during an insulation resistance measurement is repeated. In this case, “Noise Error” is displayed on the LCD and further measurement is ceased. Placing the test leads onto the LCD tends to cause this phenomenon (indications may be all cleared) ; so do not place the test leads onto the LCD.

When LCD becomes blank, rotate the Range Switch to the OFF position, and then set it to any desirable Voltage Range.

- * When measuring low resistances (in case that currents larger than the rated current is output) for a long time, the measured object or the instrument may become heat and dangerous due to high energy consumption. So this instrument automatically reduce the output voltages when measuring low resistances. A message “Stop measuring” is displayed on the LCD, when low resistances are measured for a long time, and measurements are stopped.

Temperature inside the instrument is high when “Stop measuring” is displayed and measurements are ceased. In this case, please wait at least 30 min to make further measurements.

- * The Voltage monitor may indicate 10V to 200V instead of 0V when short-circuiting the Line Probe and Earth Cord when voltages are output. In this case, voltages applied to the resistors mounted in the internal measuring circuit are included and displayed on the LCD.

Check of Power Interruption (Voltage Measurements)

⚠ DANGER

- Do not make measurement on a circuit above AC/DC600V(voltage to earth) to avoid possible electric shock.Do not make a measurement, even if a line voltage is 600V or less, when a voltage to earth is over 600V.
- When testing installation that has a large current capacity, such as a power line, be sure to make measurements on the secondary side of a circuit breaker in order to avoid possible hazard to the user.
- Extra precaution shall be taken to minimize the possibility of shorting the power line with the metal tip of test lead at voltage measurement. It may cause personal injury.
- Do not make measurement with the Battery Cover removed.

Voltage can be measured by selecting the “Vtest (Voltage)” on the Mode selection screen. (=>P.22 How to select a Measurement Mode) No need to press the Test Button to start a measurement.

This instrument is equipped with AC/DC auto-detect circuit, and can measure DC voltages. At a DC voltage measurement, when applying positive voltage to the Line Probe (red), positive values are displayed on the LCD.

- ① **Turn off the Circuit Breaker of the circuit under test.**
- ② **Connect the Earth Cord (black) to the earth side of the circuit under test and the Line Probe (red) to the line side respectively.**
- ③ **The voltage displayed on the LCD shall be “Lo V”. If not, voltages of 30V or more is applied on the circuit under test. Check the circuit under test again and confirm that the Circuit Breaker is turned off.**

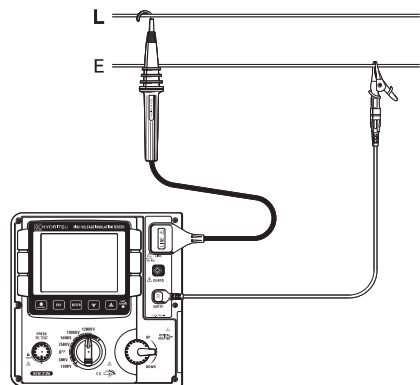

Refer to **Vtest** Voltage Measurement (=>P.69) for further details on the indications on the LCD.

6.1.3 Setting for Measurement

Select a mode at Measurement Mode Selection Screen, and make settings for measurements.

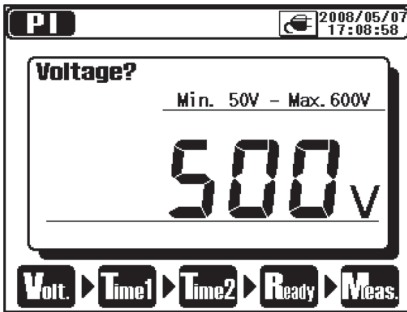

Setting items are displayed on the LCD one by one.

Use the **UP/DOWN Key** and **Shuttle Switch** and alter the values, and press the **ENTER Key** to confirm the entry and move to the next setting item. Pressing the **ESC Key** returns to the previous item. All the set items are displayed on the LCD once settings are done. Press the **ENTER Key**

at a Confirmation Screen to get the instrument entered into a stand-by mode. A process from making the setting to a start of measurement is displayed at the bottom of the LCD with the corresponding stage mark flashing. The Measurement Setting Screen is also accessible from the Menu. (=>P.37 Menu)

Setting of Output Voltage

Output voltage can be selected with the Range Switch first, and then fine adjusted with the Cursor Keys. Selected voltage values cannot be altered while making measurements or outputting voltages.

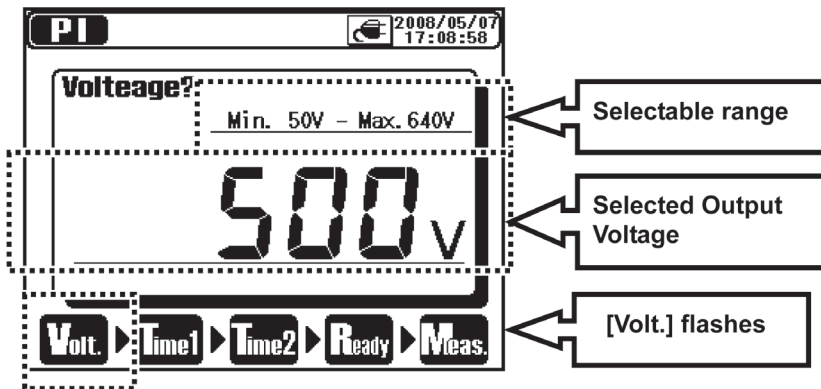

The table below shows the selectable range of voltages and step values at each Measurement Range.

Range	Step	Min	Max
500V	5V	50V	600V
1000V	10V	610V	1200V
2500V	25V	1225V	3000V
5000V	50V	3050V	6000V
10000V	100V	6100V	10000V
12000V	100V	10100V	12000V

Setting of Measurement Period

TIME1 & 2 for PI/DAR Measurements, TIME for DD Measurements and Step time for SV Measurements can be altered respectively.

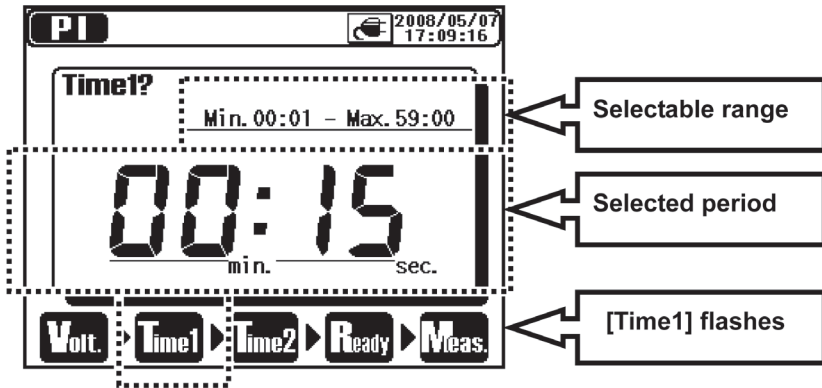



The table below shows the step values for each selectable period.

Selectable period	Step
15 sec – 1 min	1 sec
1 min – 10 min	30 sec
10 min – 60 min	1 min

The lower bound value of each measurement mode at the set time is 15 seconds.

6.1.4 Graph Operation

Selecting the “ **Time Axis ZOOM**” or “ **Measured Value Axis ZOOM**” from the **ENTER Menu** (=>P.37) on the Graph Display Screen enters into Graph ZOOM Mode. In this mode, zooming and scrolling of graphs are available. A short press (within 1 sec) of the **ESC Key** in the Graph ZOOM Mode quits the Graph ZOOM Mode and returns to a normal Graph Display Screen. The instrument keeps the zoomed percentage and the scrolled condition.

Zooming in/ out of graphs

Use the **UP Key** to zoom in the graph and the **DOWN Key** to zoom out. The Voltage Axis at SV measurements is fixed and cannot be changed.

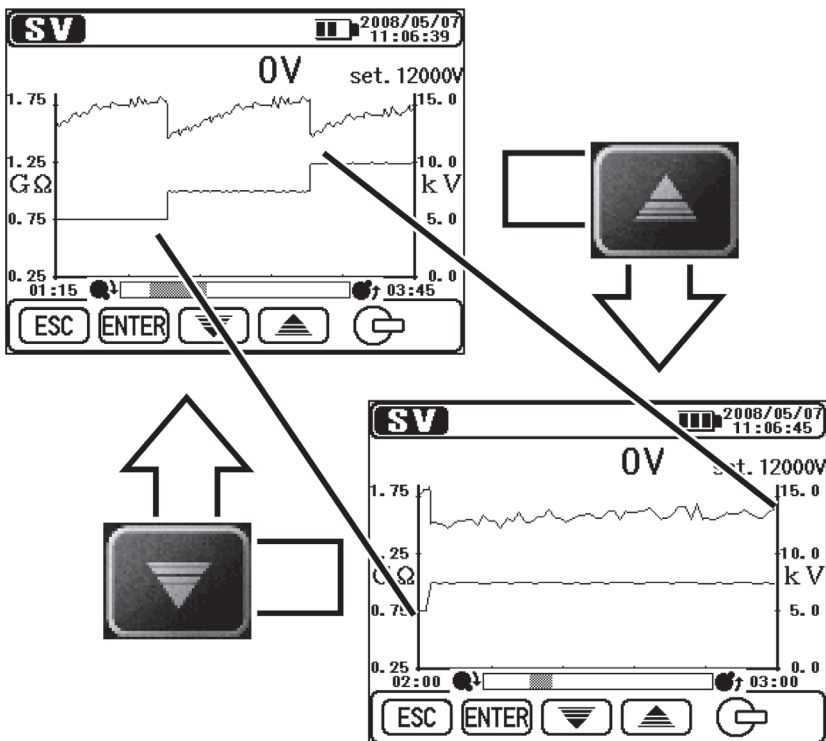

Switching the axis subject to zoom

A short press (within 1 sec) of the **ENTER** Key switches the Measured Value Axis and the Time Axis to be zoomed.

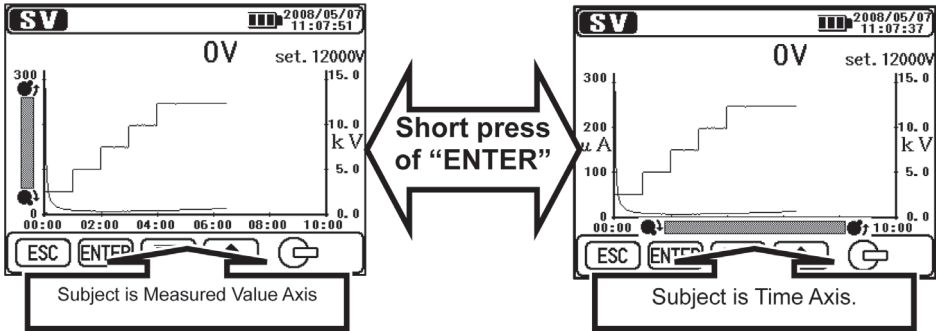

● Scroll Bar at Measured Value Axis

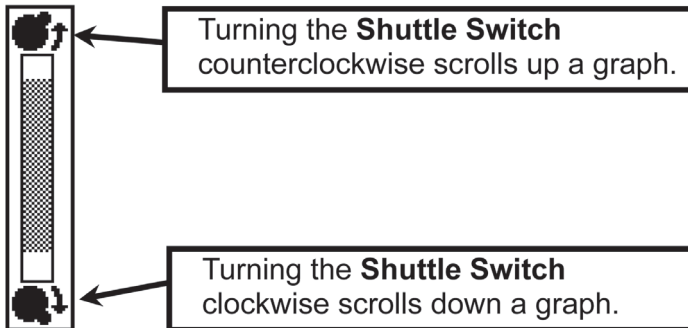

● Scroll Bar at Time Axis

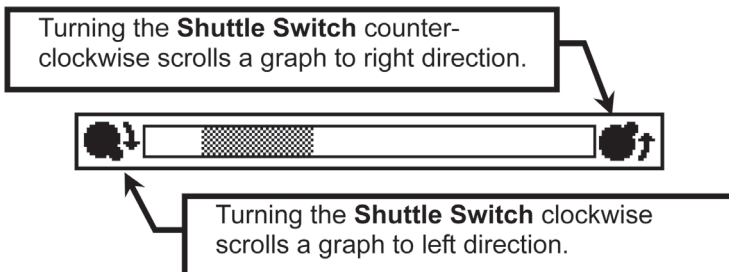

Scrolling of Graph

Turn the **Shuttle Switch** to scroll a graph. The Voltage Axis at SV measurements is fixed and cannot be scrolled.

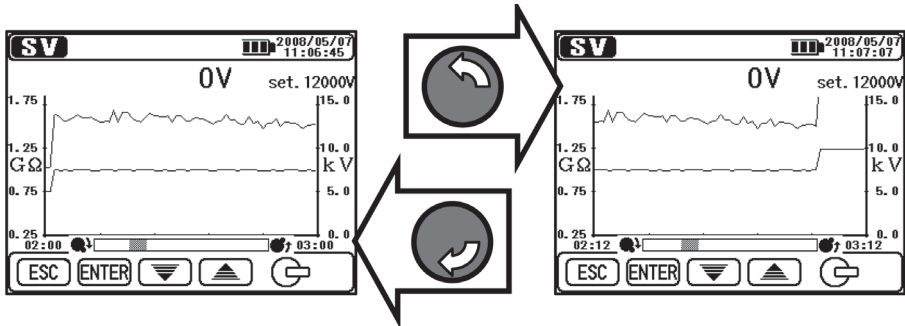

Switching the displayed graphs

A **long press** (1 sec or longer) of the **ENTER Key** switches Current and Resistance graphs.

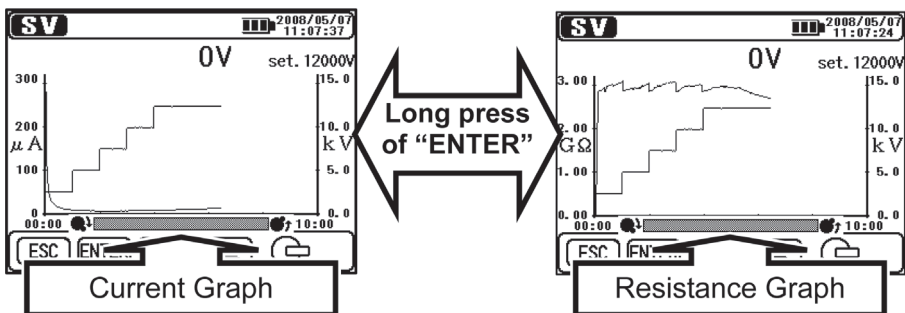

Displaying in Full-scale

A **long press** (1 sec or longer) of the **ESC Key** displays a graph in full-scale. Displaying a graph in full-scale is also possible from the **ENTER Menu** (=>P.37). Quit the Graph ZOOM Mode and select “ **Full-scale Display**” from the ENTER Menu.

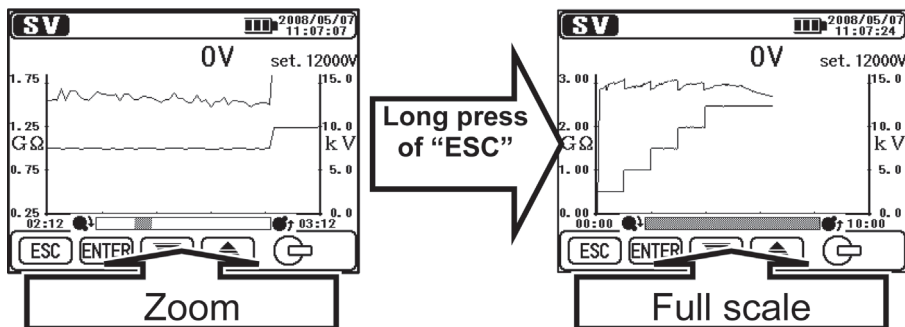

6.1.5 Menu

The Menu is available when “**Menu**” is being displayed on the upper middle of the LCD.

Pressing the **ENTER Key** while “**Menu**” is being displayed on the LCD pops up the Menu Window.

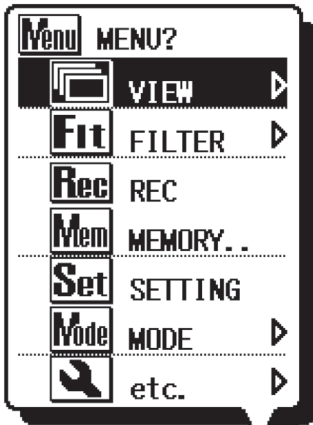











Move the cursor with the **UP/DOWN Keys** or **Shuttle Switch**, and confirm the selection with the **ENTER Key**. Pressing the **ESC Key** while the Menu is being displayed closes the Menu Window.

Items displayed with “▶” mark are accompanied with submenus. Press the **ENTER Key** to access to the submenus.



Pressing the **ESC Key** (within 1 sec) while the submenus are being displayed returns to the previous screen. A long press (1 sec or longer) of the **ESC Key** closes the Menu Window.

Followings are the details of each menu item.

Icon	Name	Function
	View Change	Switches the screens. (=>P.39 View Change)
	Graph ZOOM	Selects the Graph Zoom Mode. (=>P.39 Graph ZOOM)
	Filter	Makes setting for the Filter Mode. (=>P.40 Filter)
	Record	Records measured results continuously.
	Save	Saves the measured results only.
	Internal Memory	Recalls or deletes the data in the internal memory. (=>P.42 Save Data)
	Setting	Moves to Measurement Setting Screen.
	Mode Change	Changes Measurement Modes.
	Others	Makes setting for clock. (=>P.40 Other Functions)
	EXIT	Exits from Result Display Screen and returns to Stand-by Mode.



View Change

Switches among Measured value, Current Graph and Resistance graph views. Each sub-menu item has following function.

Icon	Name	Function
	Measured value	Displays Measured value View.
	Current Graph	Displays Current Graph View.
	Resistance Graph	Displays Resistance Graph View.

Graph ZOOM





Enters into the Graph Zoom Mode (=>P.33 Graph Operation), and displays a graph in full-scale. Each sub-menu item has following function.

Icon	Name	Function
	Time Axis ZOOM	Zooms a graph with reference to the Time Axis (X-Axis).
	Measured value Axis ZOOM	Zooms a graph with reference to the Measured Value Axis (Y-Axis).
	Full-scale Display	Displays a graph in full-scale.

Filter

Switches on/off the Filter Function. (=>P.41 Filter Mode)



Each sub-menu item has following function.

Icon	Name	Function
	Filter OFF	Displays the Measured Value View.
	Filter 1	Enables Filter 1
	Filter 2	Enables Filter 2
	Filter 3	Enables Filter 3

Other Functions

Make settings for the instrument.

Each sub-menu item has following function.

Icon	Name	Function
	Clock Setting	Set the clock for KEW3128 instrument. (=>P.47 Clock Setting)
	Print Screen	Save the screen displayed on the LCD as a BMP (bitmap) file. Act same as a long press (1 sec or longer) of the Print screen /Backlight Key . (=>P.17 Keys)
	Demo Mode	Switch to the Demo mode. (=>P.47 Demo mode)

6.1.6 Filter Mode

The KEW3128 has following 3 kinds of Filter Functions.

Filter Mode is effective to reduce the variations in readings due to external influences during high resistance measurements.

Effectiveness of the Filter Mode becomes stronger when values get bigger. To check sudden variations in resistances, the Filter Mode should be disabled.

Name	Function
Filter OFF	Disables the Filter (default setting)
Filter 1	Low-pass Filter (fc = 0.3Hz)
Filter 2	Moving Average (average of 5 data)
Filter 3	Low-pass Filter + Moving Average

Filter 1 : It uses it to cut the exchange element more than industrial frequency (50/60Hz) when a high electric field has been generated around the measurement thing.

Filter 2 : Four data immediately before the latest measurements and the latest measurements are averaged.

Filter 3 : Filter 1 and Filter 2 are used at the same time.

6.1.7 Save Data

Types of Save Data

The KEW3128 handles following 3 types of data.

● Logging Data (REC File)

Record the measured values (voltage, current and resistance values) at every 1 sec from the beginning to the end of a measurement.

The max recording period is 90 min. **The “Rec” Measurement Recoding should be selected on the ENTER Menu (=>P.37) while the instrument is in the Stand-by mode to save the Logging data.**

The time displayed at the top of the LCD indicating the time left that data can be recorded. (=>P.65)

Data is saved as “RECXX”. (XX : 01~32)

Logging data (REC file) is recorded and saved in 15 seconds later from the beginning of a measurement.

The data 15 seconds or earlier is shown as “--”. When viewing a graph on the LCD of the instrument, the measured results for 15 seconds from the beginning of a measurement are displayed with a straight line.

* It is same in real-time measurements using the supplied software “KEW Windows”.

The measured value is saved in 15 seconds later from the beginning of a measurement and the data 15 seconds or earlier is shown as “--”.

● Measured Data (SAVE File)

Measured data contains measured results only.

Select the “Save” Saving Measured Results on the ENTER Menu (=>P.37) while the measured results are displayed on the LCD.

Data is saved as “SAVEXX”. (XX : 01~32)

● Print Screen (BMP File)

Captures and saves the screen images. **A long press (1 sec or longer) of the Print Screen/ Backlight Key saves screen images.**

Data is saved as “BMPXX”. (XX : 01~32)

List of the Saved data

Select the “**Mem**” Internal Memory on the ENTER Menu (=>P.37). Then a list of saved data is displayed as follows.

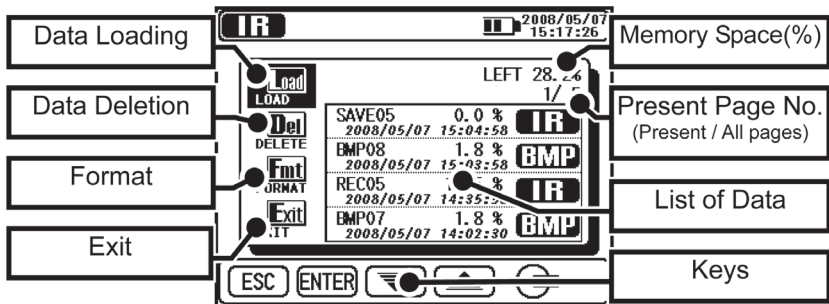

Functions to recall (=>displays the saved data), delete (=>deletes the saved data) and format the data (=>formats the internal memory) are available. Details of each parameter are as follows.

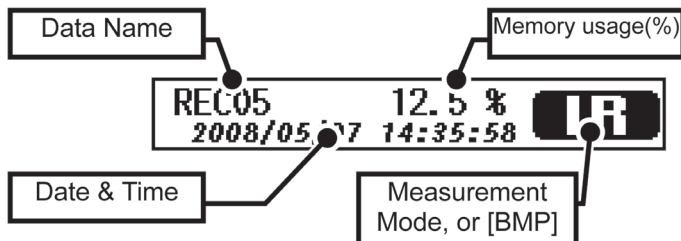

The latest data is displayed on the top.

Recall the Saved Data

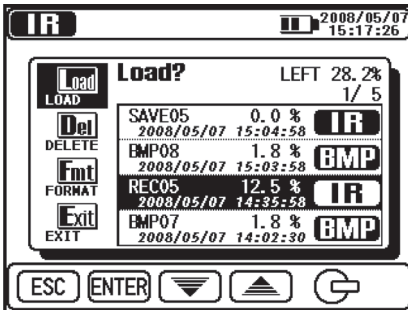

Display a list of the saved data.

Then use the **UP/DOWN Key** or **Shuttle Switch** and move the cursor onto **[LOAD]**, and press the **ENTER Key**. The highlighted cursor is displayed, and can be moved on the files. Put the cursor on a desirable file with the **UP/ DOWN Key** or **Shuttle Switch** and press the **ENTER Key**.

A Confirmation Screen appears. Press the **ENTER Key** to load the selected data.

Pressing the **ESC Key** cancels to load the data.

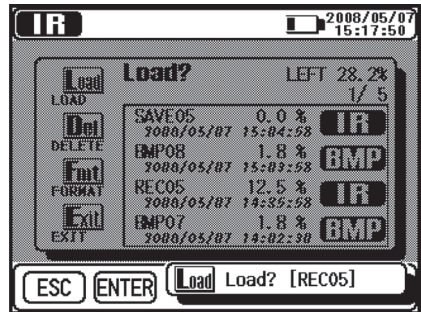

Displayed parameters are dependent on the selected files.

● Display the Logging data

The results of the saved data and the graphs of currents and resistances can be displayed. The available operations against the displayed data are same to that available when finishing measurements. Press the **ESC Key** to return to the previous screen.

Items displayed at the top of the LCD are as follows.

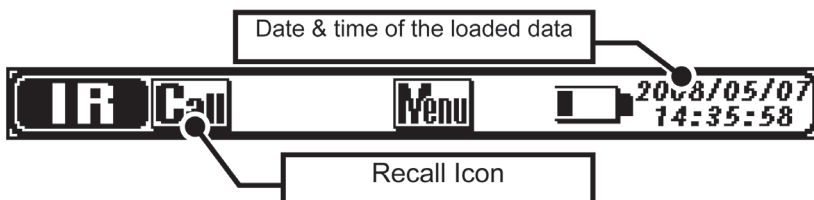

● Display the Measured Data

Only the measured results can be viewed. The Graph Function isn't available. The available operations against the displayed data are same to that available when finishing measurements. Press the ESC Key to return to the previous screen. Items displayed at the top of the LCD are same to the display for the Logging data.

● Display the Print Screen

Display the saved BMP files. A black frame is displayed with flashing around the LCD. Press the ESC Key to return to the previous screen.

Delete the saved data

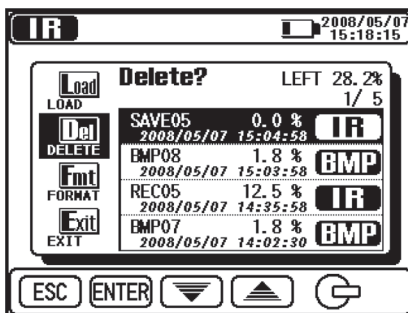

Display a list of the saved data.

Then use the **UP/DOWN Key** or **Shuttle Switch** and move the cursor onto **[DELETE]**, and press the **ENTER Key**. The highlighted cursor is displayed, and can be moved on the files. Put the cursor on a file with the **UP/DOWN Key** or **Shuttle Switch** and press the **ENTER Key** to delete it.

A Confirmation Screen appears. Press the **ENTER Key** to load the selected data. Pressing the **ESC Key** cancels to load the data.

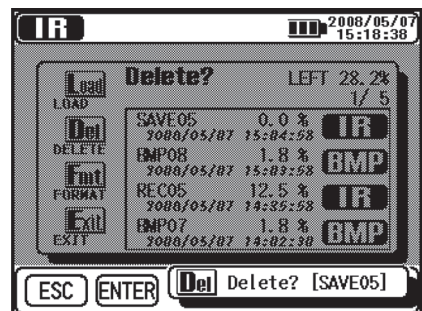

Format of the Internal Memory

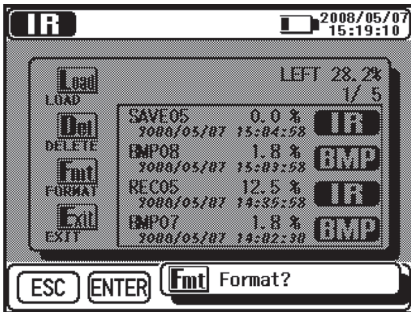

Display a list of the saved data.

Then use the **UP/DOWN Key** or **Shuttle Switch** and move the cursor onto **[FORMAT]**, and press the **ENTER Key**. Then the memory is formatted and the List Display Screen is displayed. Press the **ESC Key** to cancel a format.

Max number of files that can be saved

The max number of files that can be saved is **32 files in total**; adding up all the Logging, Result and Print Screen data.

The save capacity is for 43000 data / for about 720 min in total (in case of Logging data only). Max number of files that can be saved is dependent on the file type.

File Type		Max number of files that can be saved
Logging Data	10-min data	32 files
	30-min data	23 files
	60-min data	11 files
	90-min data	7 files
Measured Data		32 files
Print Screen		32 files

6.1.8 Clock Setting

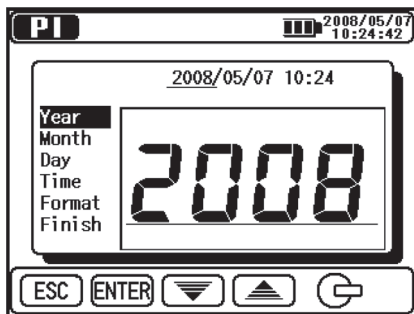

Select “” Clock Setting on the ENTER Menu (=>P.37). Adjust the time in a following order: [year], [month], [day], [hour], [minute] and [display format]. Pressing the **ENTER Key** confirms the entry and proceeds to next step. Press the **ESC Key** to return to the previous item.

Pressing the **ENTER Key** (1 sec or longer) while [Finish] is highlighted makes the new setting effective. A long press of the **ESC Key** returns to the previous screen.

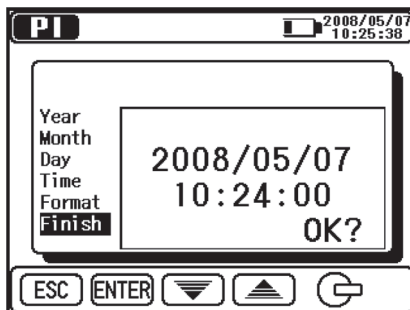

6.1.9 Demo Mode

KEW3128 has a Demo mode function to display simulated data as measured results without generating output voltages.

Communication and save operations work same as that work under normal mode. The  mark flashes at the top of the LCD while the instrument is in Demo mode.

Demo mode isn't canceled after powering off the instrument.

Access from the ENTER menu (=> P. 37) to exit from the Demo mode.

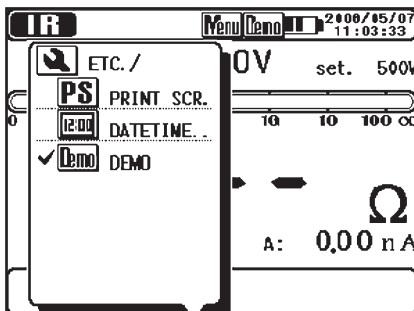

6.2 Insulation Diagnosis Tests

This instrument can measure and perform following items as a part of Insulation resistance Test.

- Insulation Resistance (IR)
- Polarization Index (PI)
- Dielectric Absorption Ratio (DAR)
- Dielectric Discharge (DD) *Auto-testing
- Step Voltage Test (SV)

Measurement Mode	Function
Insulation Resistance (IR)	Performs normal insulation resistance measurements (consistent measurements)
Polarization Index (PI)	Measures resistances twice and calculates polarization index automatically. (default value: 1 min, 10 min)
Dielectric Absorption Ratio (DAR)	Measures resistances twice and calculates dielectric absorption ratio automatically. (default value: 15 sec, 1 min)
Dielectric Discharge (DD)	Calculates dielectric discharge based on the measured capacitance of the measured object and residual current values after testing.
Step Voltage Test (SV)	Increases the set voltage by 20% every time when pre-set time comes.

6.3 IR Measurement

6.3.1 Setting Item

Setting items for IR measurements are as follows. Refer to **Setting for Measurement** (=>P.30) and change the setting values.

At IR measurements, continuous measurements over 90 min are possible , however, the displayable area of the recorded data and graph are 90 min of measured results. The later portions are displayed with numbers only.

Icon	Name	Details
	Output voltage value	Voltages to be output

6.3.2 Measured Result

The result of IR measurement is displayed as follows.

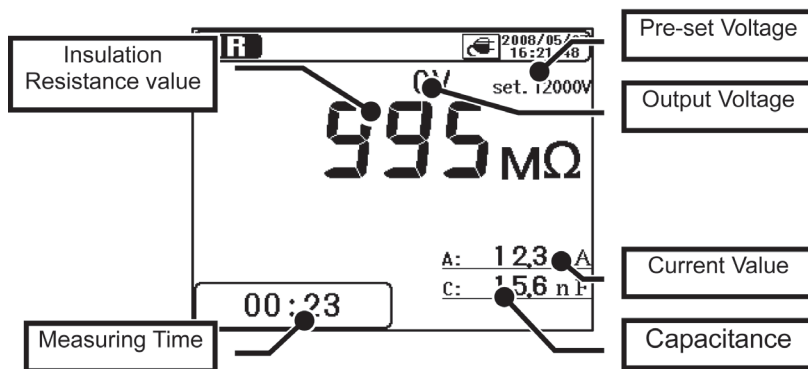

Displayed Items	Details
Insulation Resistance	Measured insulation resistance value
Measuring Time	Elapsed time from a beginning of a measurement
Pre-set Voltage	Pre-set output voltage value
Output Voltage	Voltage being output
Current value	Current value being measured
Capacitance	Capacitance measured at discharge.

6.4 **PI** PI Measurement (Polarization Index)

6.4.1 Polarization Index

PI : Polarization Index

This is a test to check a temporal increase of leakage currents flowing on insulations. To determine a Polarization Index, first, measure insulation resistance at 1 min intervals for 10 min. Then, divide the final value by the initial reading and calculate a ratio. PI is dependent on the shape of insulations and influenced by moisture absorption, therefore, a check of PI is important to diagnosis the insulation of cables.

$$\text{Polarization index} = \frac{\text{TIME 2 Insulation resistance value 3 or 10 min after starting measurement}}{\text{TIME 1 Insulation resistance value 30 sec or 1 min after starting measurement}}$$

PI	4.0 or more	4.0 ~ 2.0	2.0 ~ 1.0	1.0 or less
Criteria	Best	Good	Warning	Bad

6.4.2 How to measure PI

1. Select the “PI(Polarization Index)” on the Mode Selection Screen. Refer to Basic Operation (=>P.21) and operate the Screen.

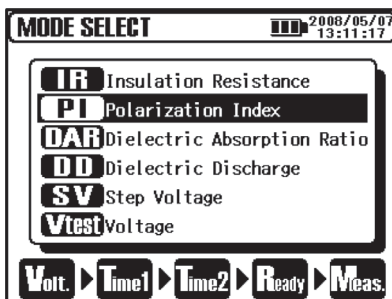

2. Set Voltage values.

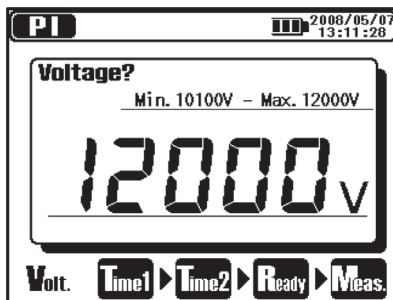



3. Set TIME1.

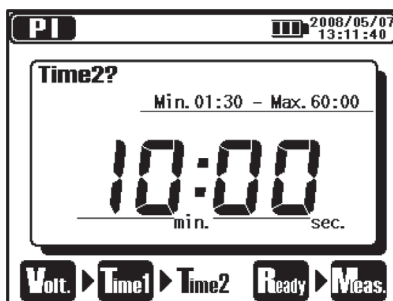

4. Set TIME2.



The instrument gets into the Stand-by Mode when settings are made. Setting items for PI measurement are as follows. Refer to the **Setting for Measurement** (=>P.30) and change settings.

Icon	Name	Details
	Output Voltage	Voltage to be output.
	PI Time 1	Measurement doesn't stop when PI Time 1 has been passed.
	PI Time 2	A measurement stops automatically when this set time comes. This value should be bigger than PI TIME 1.

DAR Simultaneous display

DAR value is displayed during PI measurements and the measured results are being displayed. TIME 1 and 2 values for DAR are the ones pre-set in the DAR mode. Refer to **6.5.2 How to measure DAR (=>P.55)** and set the time for DAR. In case that DAR TIME 2 value is higher than PI TIME 2 value, DAR value isn't displayed on the LCD. A measurement stop when the PI TIME 2 comes. PI value isn't displayed in the DAR measurement mode.

6.4.3 Measured Result

The result of PI measurement is displayed as follows.

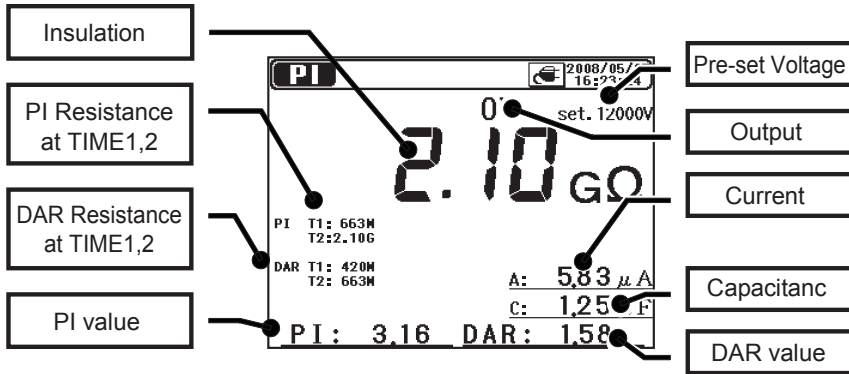

Displayed Items	Details
Insulation Resistance	Measured insulation resistance value
PI Resistance at TIME1,2	PI Resistance value at TIME1 and TIME2
DAR Resistance at TIME1,2	DAR Resistance value at TIME1 and TIME2
PI	Polarization Index value
Pre-set Voltage	Pre-set output voltage value
Output Voltage	Voltage being output
Current value	Current value being measured
Capacitance	Capacitance measured at discharge
DAR	Dielectric Absorption Ratio

6.5 **DAR** DAR Measurement (Dielectric Absorption Ratio)

6.5.1 Dielectric Absorption Ratio

DAR : Dielectric Absorption Ratio

DAR measurement is almost same to PI measurement in a sense that they test the time course of insulation. The only difference is that DAR measurement can get result faster than the other.

$$\text{Dielectric Absorption Ratio} = \frac{\text{TIME2 Insulation resistance value 30 sec or 1 min after starting measurement}}{\text{TIME1 Insulation resistance value 15 or 30 sec after starting measurement}}$$

DAR	1.4 or more	1.25 ~ 1.0	1.0 or less
Criteria	Best	Good	Bad

6.5.2 How to measure DAR

1. Select the “DAR (Dielectric Absorption Ratio)” on the Mode Selection Screen. Refer to **Basic Operation** (=>P.21) and operate the Screen.

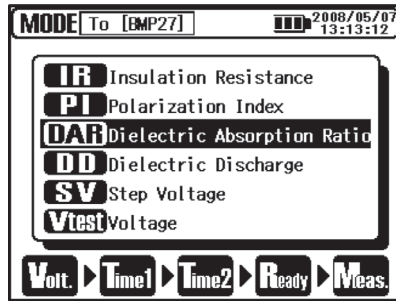

2. Set Voltage values.

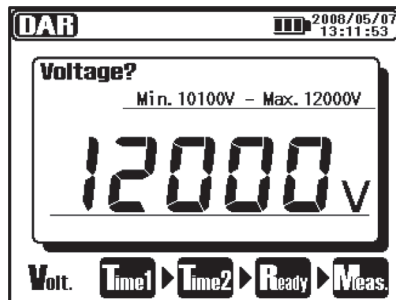



3. Set TIME1.



4. Set TIME2.



Setting items for DAR measurement are as follows. Refer to the Setting for Measurement (=>P.30) and change settings.

Icon	Name	Details
	Output Voltage	Voltage to be output.
	DAR Time 1	Measurement doesn't stop when PI Time 1 has been passed.
	DAR Time 2	A measurement stops automatically when this set time comes. This value should be bigger than PI TIME 1.

6.5.3 Measured Result

The result of DAR measurement is displayed as follows.

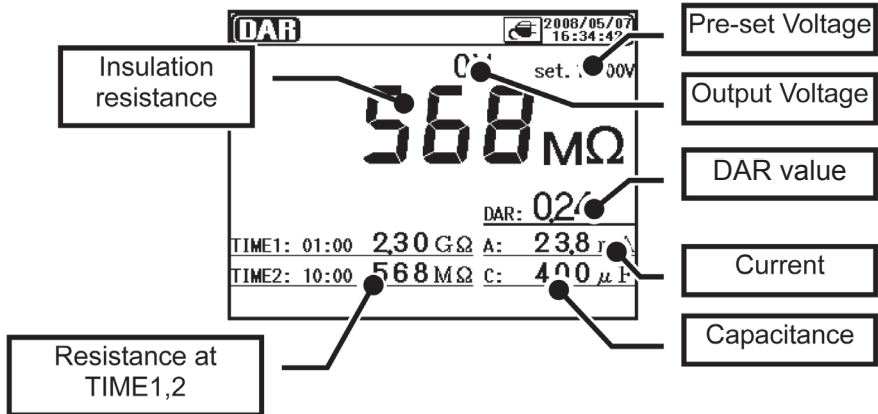

Displayed Items	Details
Insulation Resistance	Measured insulation resistance value
Resistance at TIME1,2	Resistance value at TIME1 and TIME2
Pre-set Voltage	Pre-set output voltage value
Output Voltage	Voltage being output
DAR	Dielectric Absorption Ratio
Current	Current value being measured
Capacitance	Capacitance measured at discharge.

6. 6 **III** DD Measurement (Dielectric Discharge)

6.6.1 Dielectric Discharge

DD : Dielectric Discharge

This measurement method is usually used to diagnosis multi-layer insulations, which requires the instrument to measure the discharge current and capacitance of the measured object 1 min after the removal of the test voltage. This is a very good diagnostic insulation test that allows deterioration and other problems voids in the multiple insulations to be assessed.

$$\text{Dielectric Discharge} = \frac{\text{Current value 1 min after completing measurement (mA)}}{\text{Voltage value when a measurement complete x Capacitance (F)}}$$

DD	2.0 or less	2.0 ~ 4.0	4.0 ~ 7.0	7.0 or more
Criteria	Good	Warning	Poor	Very Poor

This criteria is a guide and could be slightly changed and be adapted to particular objects under test based on practical experience of the users.

This method has been established to test high voltage generators installed in electric power plants in the Europe countries.

6.6.2 How to measure DD

1. Select the “DD (Dielectric Discharge)” on the Mode Selection Screen. Refer to **Basic Operation** (=>P.21) and operate the Screen.

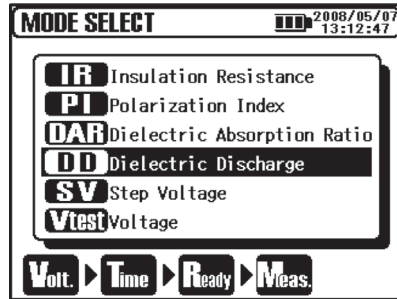

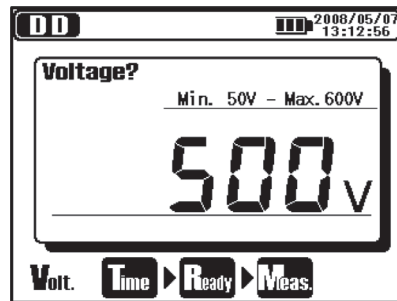

2. Set Voltage values.



3. Set TIME.



Setting items for DD measurement are as follows. Refer to the Setting for Measurement (=>P.30) and change settings.

Icon	Name	Details
	Output Voltage	Voltage to be output
	Measuring Time	Measurements stop automatically and DD values are calculated.

6.6.3 Measured Result

The result of DD measurement is displayed as follows.

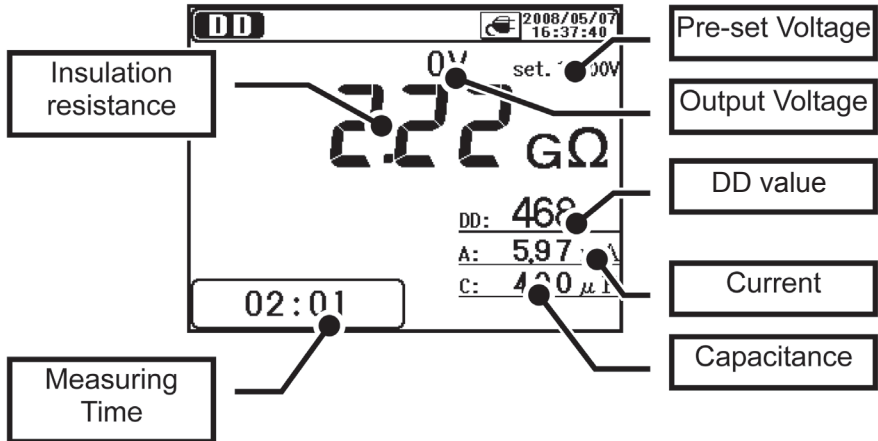

Displayed Items	Details
Insulation Resistance	Measured insulation resistance value
Measuring Time	Elapsed time from a beginning of a measurement
Pre-set Voltage	Pre-set output voltage value
Output Voltage	Voltage being output
DD	Dielectric Discharge
Current	Current value being measured
Capacitance	Capacitance measured at discharge.

6.7 **SV** SV Measurement (Step Voltage)

6.7.1 Step Voltage

SV : Step Voltage

This is a test based on the principle that an ideal insulation will produce identical readings at all voltages, while an insulation which is being over stressed, will show lower insulation values at higher voltages. During the test, the applied voltage incrementally steps by a certain voltage taking successive 5-time measurement. Degradation of insulation may be doubt when insulation resistances become lower at higher applied voltages.

6.7.2 Measurement Setting Items

1. Select the “SV (Step Voltage)” on the Mode Selection Screen. Refer to **Basic Operation** (=>P.21) and operate the Screen.

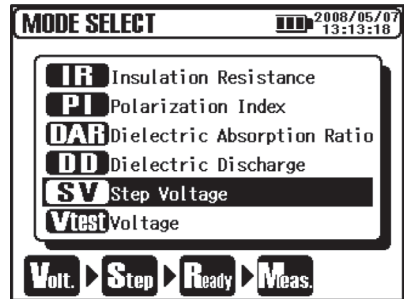

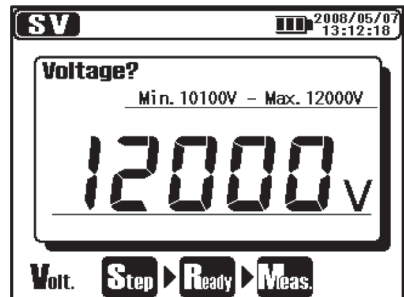

2. Set Voltage values.



3. Set Step Time.



Setting items for SV measurement are as follows. Refer to the Setting for Measurement (=>P.30) and change settings.

Icon	Name	Details
	Output Voltage	Voltage to be output
	Step Time	Time per step

In the SV measurement mode, measurements continue after the preset Step time (V5) comes and automatically stop when 90 min pass.

6.7.3 Measured Result

The result of SV measurement is displayed as follows.

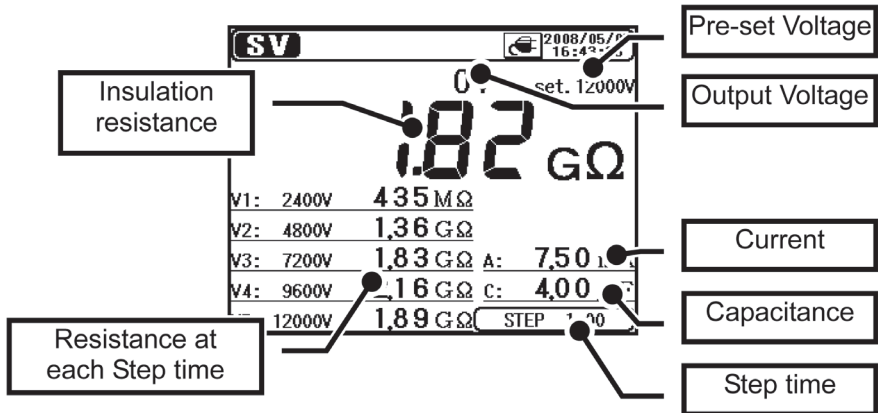

Displayed Items	Details
Insulation Resistance	Measured insulation resistance value
Resistance at each Step time	Resistance value at each Step time (V1 – V5)
Pre-set Voltage	Pre-set output voltage value
Output Voltage	Voltage being output
Current	Current value being measured
Capacitance	Capacitance measured at discharge
Step time	Pre-set Step time

6.8 Measurement Screen

Displayed items at the top of the LCD

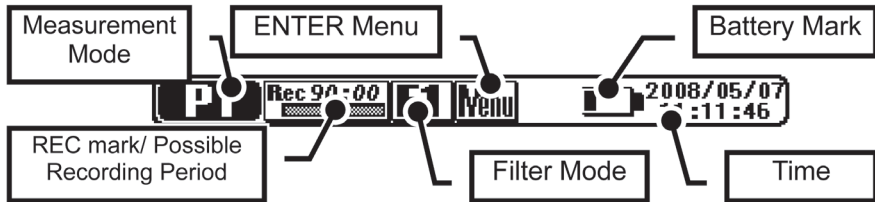

Displayed Items	Details
Measurement Mode	Mark of the selected Measurement Mode
REC mark/ Possible Recording Period	Displayed when "REC" is specified. Possible recording time is displayed with a bar graph and numbers.
Filter Mode	Mark of the selected Filter
ENTER Menu	Accessible to the ENTER Menu when pressing the ENTER Key while this icon is being displayed.
Battery Mark	Mark indicating the level of battery voltage. Different mark is displayed when the instrument is operating with an external power supply.
Time	Present time and date

Items displayed at Result Display Screen

Following items are displayed on the LCD in stand-by mode and during a measurement.

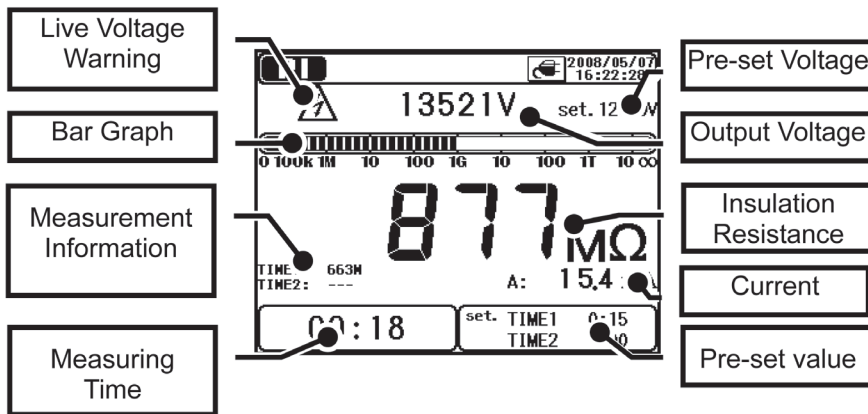

Displayed Items	Details
Live Voltage Warning	Displayed while voltages are being output. Flashing status shows discharge is in progress.
Bar Graph	Bar graph indicating the measured insulation resistances
Measurement Information	Supplementary info about each measurement mode.
Measurement Time	Elapsed time after a start of measurement
Pre-set Voltage	Pre-set output voltage value
Output Voltage	Voltage being output
Insulation Resistance	Insulation resistance value being measured
Current	Current value being measured
Pre-set Value	Pre-set values for each Measurement Mode

Items displayed at Graph Display Screen

Following items are displayed on the LCD with in stand-by mode and During a measurement.

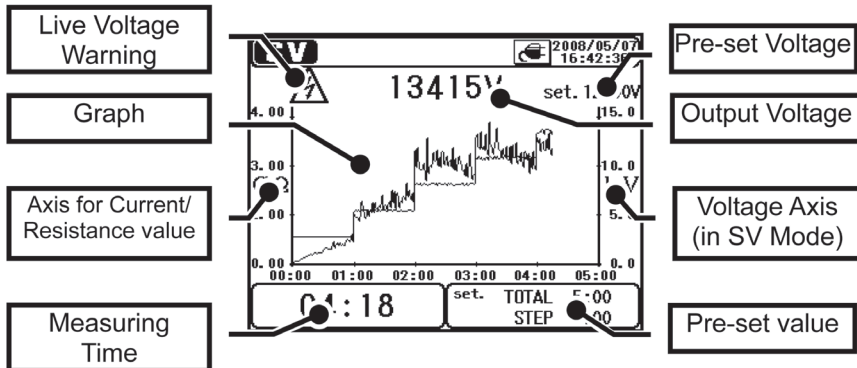

Displayed Items	Details
Live Voltage Warning	Displayed while voltages are being output. Flashing status shows discharge is in progress.
Graph	Bar graph indicating the measured insulation resistances.
Axis for Current/ Resistance values	Axis is switched between current and resistance values depending on each graph.
Measuring Time	Elapsed time after a start of measurement
Pre-set Voltage	Pre-set output voltage value
Output Voltage	Voltage being output
Voltage Axis (in SV Mode)	Voltage Axis is displayed only in the SV Measurement Mode.
Pre-set Value	Pre-set values for each measurement mode

6.9 Capacitance Measurement

6.9.1 Measurement Screen

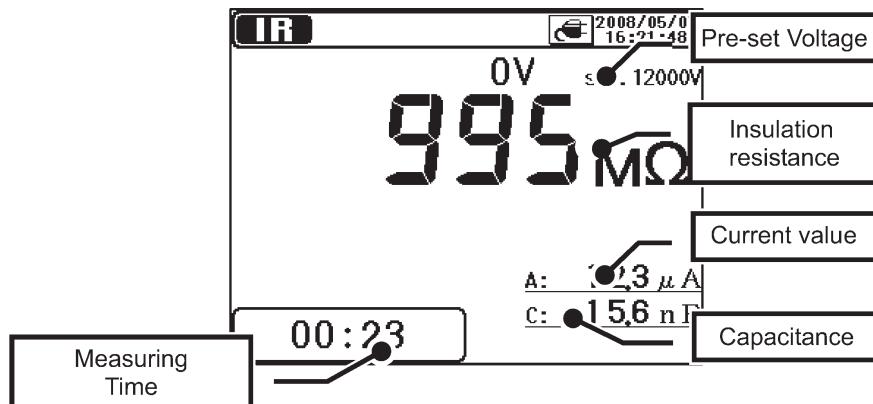

Displayed Items	Details
Capacitance value	Displays capacitance values of the measured object after insulation resistance tests.
Measuring Time	Elapsed time after a start of measurement

At capacitance measurements, measured values are displayed when insulation resistance measurements complete. When the output voltages are 80% or less of the preset voltage values at an insulation resistance measurement, readings for capacitance become “---”.

KEW3128 has a Protect Mode to limit charge currents in order to protect the instrument when measuring 10uF or higher. In this mode, a message “Protect mode” is displayed on the LCD.

The instrument exits from the Protect Mode automatically when a battery charge completes or 5 min pass after entering into this mode.

6. 10 **Vtest** Voltage Measurement

6.10.1 Measurement Screen

The result of Voltage measurement is displayed as follows.

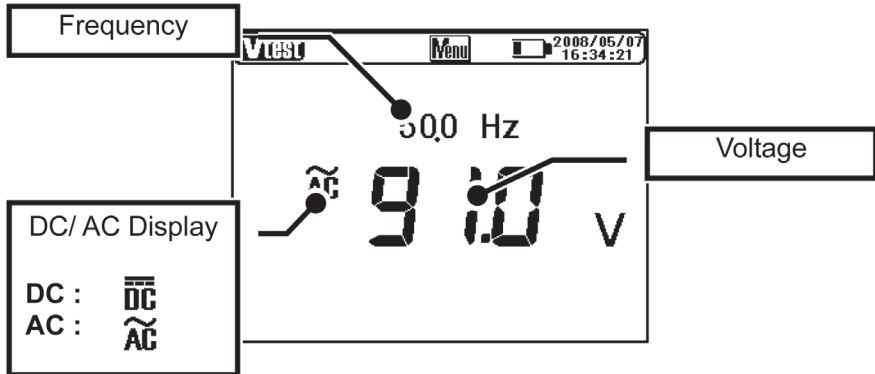

Displayed Items	Details
Frequency	Frequency being measured
DC / AC Display	DC / AC of measurement voltage
Voltage	Voltage value being measured

6. 11 Other Functions

6.11.1 Use of Guard Terminal

When measuring insulation resistances of a cable, leakage currents flowing on the surface of cable jacket and the currents flowing inside the insulator are mixed and may cause error in readings. In order to prevent such error, wind a conductive wire around the point where leakage currents flow.

Then connect it to the Guard terminal as shown in the below figure.

This is to move out the surface leakage resistance of the cable insulation to measure only the volume resistance of insulator. Use the Guard cord supplied with this instrument to connect the instrument and the Guard terminal.

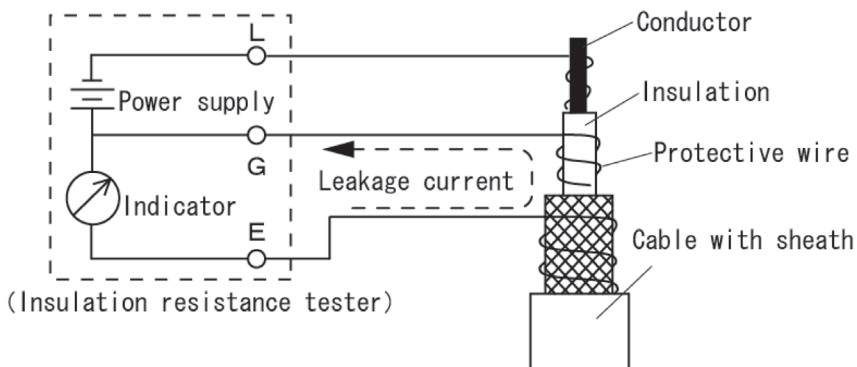

G Terminal Earthing Procedure

The G Terminal Earth System is a measurement method using a Guard Terminal which is appropriate to measure the whole electrical paths including high-voltage cable with the other high-voltage devices. Connect the Guard Terminal to the Earth Electrode of the measured object and the shielded wire of the cable to the Earth Terminal. In this case, disconnect the shielded wire of the cable from the Earth Electrode.

To use this measurement method, the insulation resistance of sheath (between the shielded wire and the ground) should be $1\text{M}\Omega$ or more.

Use of Guard Terminal at high resistance measurements

It may take longer time to obtain accurate readings when measuring high resistances of $100\text{G}\Omega$ or higher while the instrument is operated with battery instead of an external power supply.

In this case, wind the Guard Cord connected to the Guard Terminal to the Earth Cord. Then accuracy of the readings gets better.

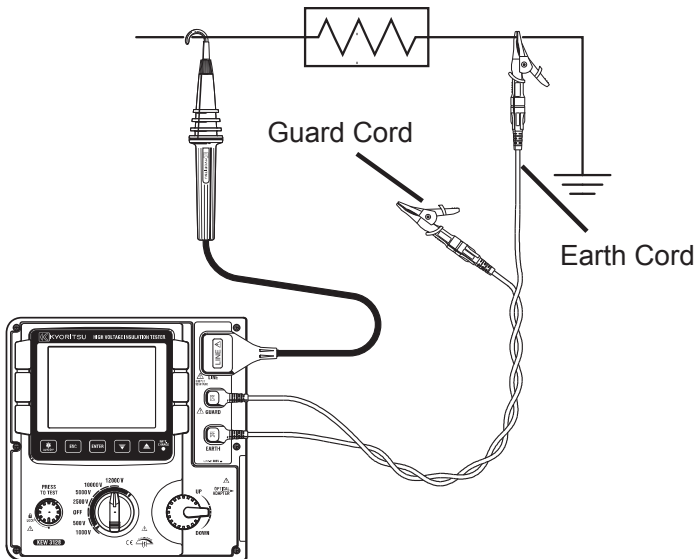

6.11.2 Backlight Function

This function to facilitate working at dimly illuminated location or at nighttime work. Press the Backlight Button when the Range Switch is at any position other than "OFF". The Backlight will light up for about 1 min., and then turned off automatically.

6.11.3 Auto-power-off Function

The instrument automatically turns off approx. 10 min after the last switch operation. The instrument automatically turns off when approx 10 min pass after a measurement with Timer function activated or 90 min of continuous measurement in SV mode completes. To return to the normal mode, turn the Range Switch to the OFF position, then to the desired position.

7. Battery Charging and Replacement

7.1 How to charge battery

 **DANGER**

Use the special cord supplied with this instrument only. Firmly connect the Power Cord to an outlet. Never connect it to a device on which electrical potentials higher than AC240V exist.

Handling and storage instructions specified by the battery manufacturer should be observed.

 **WARNING**

Connect the Power Cord to the instrument first. Cord to be firmly inserted.

Do not use the Cord if any abnormal conditions such as cracks or exposed metal parts are present. When unplugging the Cord from the mains socket outlet, do so by removing the Plug first and not by pulling the Cord.

- ① Set the Range Switch to the OFF position.
- ② Confirm a battery is installed in the instrument.
- ③ Connect the Power Cord to the instrument to feed power to the instrument.
- ④ LED Status Indicator flashes in red and the Battery Mark also flashes on the LCD.
- ⑤ The indicator lights up in green and the Battery Mark on the LCD stops flashing and lights up. (Battery charge completes in about 8 hours.)

* Battery life and how many times can be charged are depended on conditions of use and environment.

* Storing rechargeable lead-acid batteries in a low-charged state could lead to reduced life and/or damage. When storing the battery for a long period, check and charge the battery at regular intervals.

7.2 How to Replace Battery

⚠ DANGER

Never open the Battery Compartment Cover while making a measurement.

⚠ WARNING

To avoid possible electric shock, remove test leads before opening the Battery Compartment Cover. After replacing battery, be sure to tighten up the screw for Battery Compartment Cover.

⚠ CAUTION

Install a battery in correct polarity as marked inside.

- ① Remove the Power Cord from the instrument.
- ② Set the Range Switch to “OFF” position, and remove the Test Leads from the instrument.
- ③ Remove the Battery Compartment Cover-fixing screws, and slide the Cover upwards to remove it. (Attention should be paid not to lose screws.)

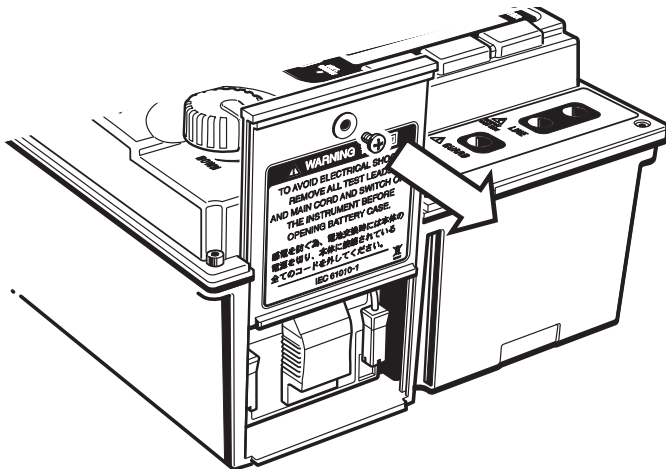

- ④ Pull out the Tray toward, and take the battery out.

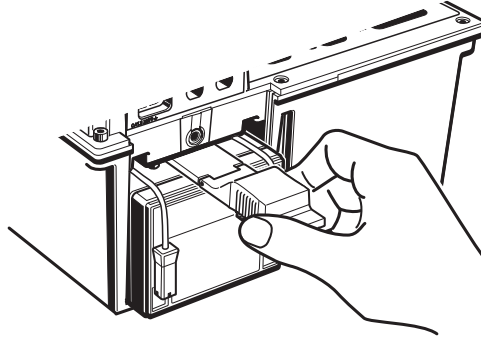

- ⑤ Pull up the Battery Connectors upward as indicated by arrow mark in the below left illustration, and remove them.

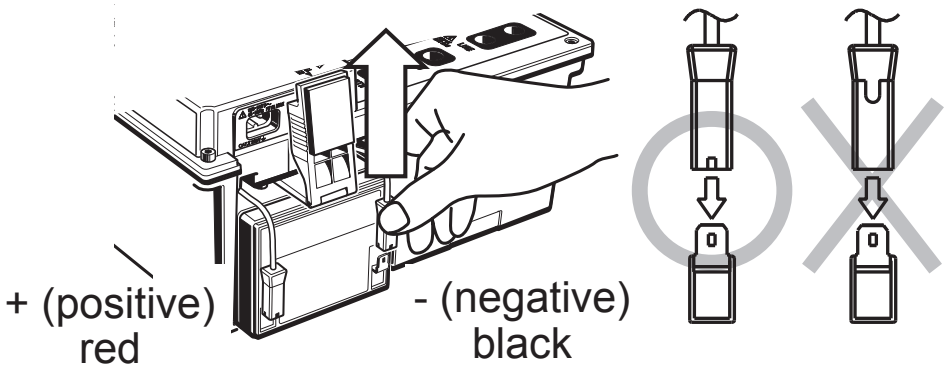

- ⑥ Remove the old battery and install a new one (rechargeable lead storage battery PXL-12050: 12V 5Ah). Check the orientation of the connectors (see above illustration on the right) and no deformation on the metal terminals and install a battery in correct polarity. Then, insert the Tray fully.
- ⑦ Install the Battery Compartment Cover so that the surfaces of the Cover and the instrument become flat, and fix it with screws.

8. Communication Function/ Supplied Software

● Interface

USB communication is possible by using this instrument with the supplied USB Adapter (M-8212).

Communication method: USB Ver1.1

Followings can be done by USB communication:

- * Downloading a file in the internal memory of the instrument to a PC
- * Making settings for the instrument via PC.
- * Displaying the measured results as a graph and saving them in real-time.

● Software

KEW Windows for KEW3128 (Supplied CD-ROM)

● System Requirements

- * OS (Operation System)

Windows2000/XP/VISTA (CPU: Pentium III 800MHz or higher)

- * Memory

256Mbyte or more

- * Display

Resolution 1024 × 768 dots, 65536 colors or more

- * HDD (Hard-disk) space required

100Mbyte or more

- * .NET Framework (2.0 or later)

● Trademarks

- * Windows® and Microsoft® Excel are the registered trademark of Microsoft in the United States.

- * Pentium is a registered trademark of Intel in the United States.

8.1 How to install the Software

Followings are the instructions to install the software “KEW Windows” and “KEW Windows for KEW3128”.

- ① Before installing the software, followings shall be checked.
 - To prepare your system to install this software, please close all open programs.
 - Be sure NOT to connect the instrument with USB until install is completed.
 - Installation shall be done with administrative right.
- ② Insert the CD-ROM in your PC's CD-ROM drive.

When the setup program doesn't run automatically, double click the "KEWLauncher.exe".

Then following window appears. Click “Next”.

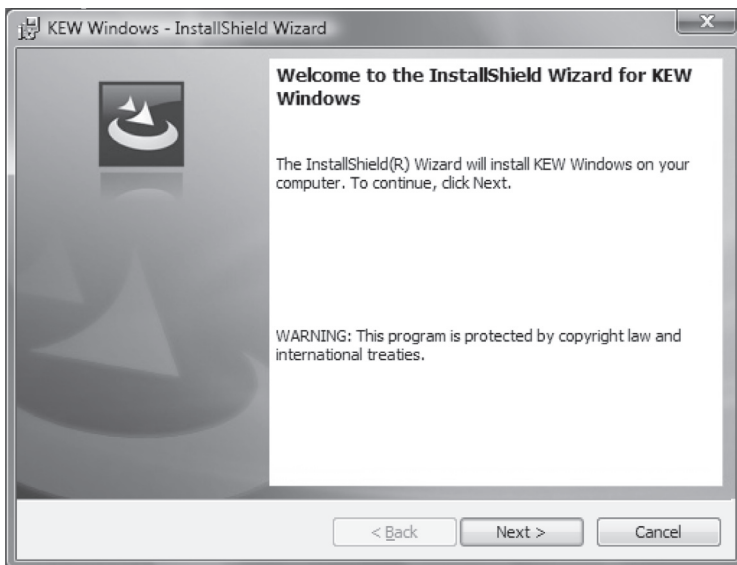

- ③ Read through and understand the License Agreement, and check “I accept....”. Then click “Next”.

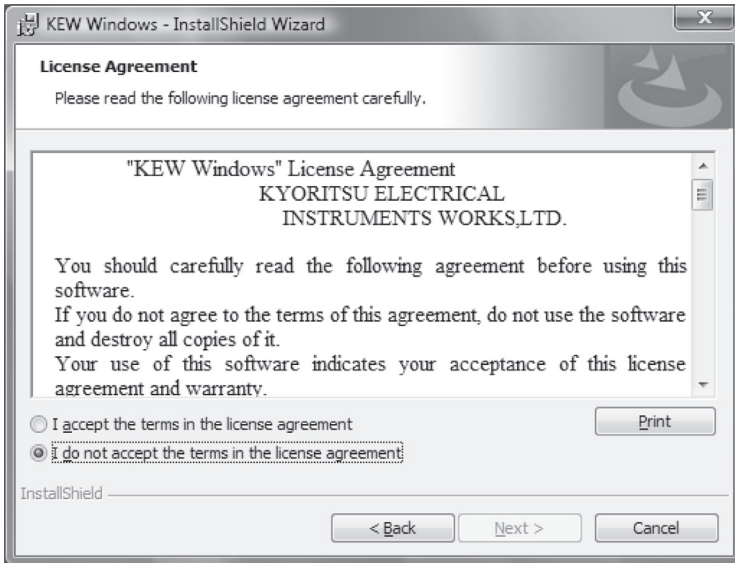

- ④ Enter the user information and specify the location to where install the software. Then click “Next”.

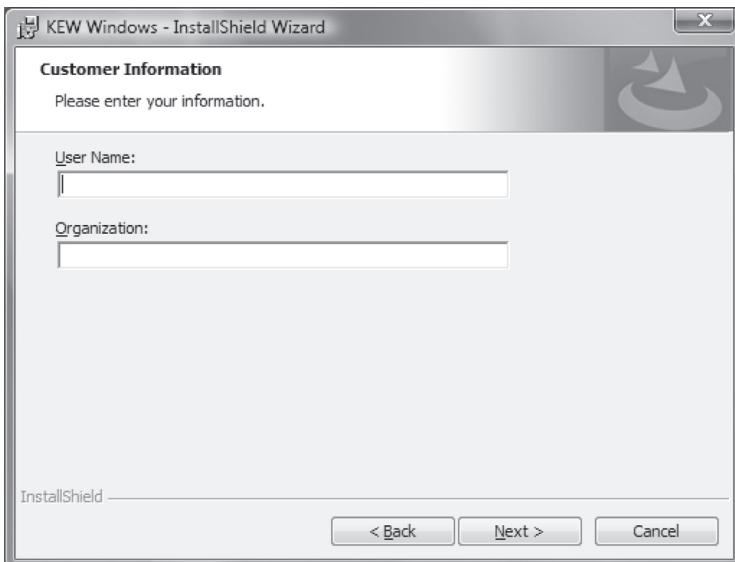

- ⑤ Confirm the information on install, and click “Install” to start installing.

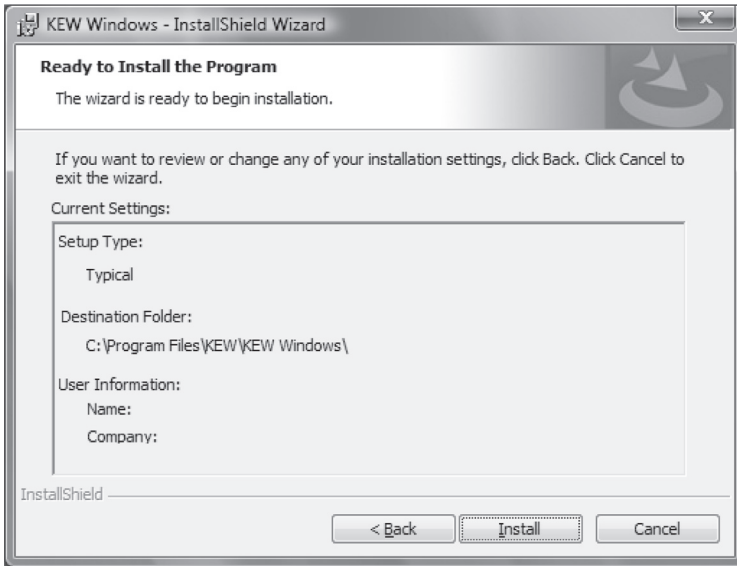

- ⑥ Click “Finish” when install completes.

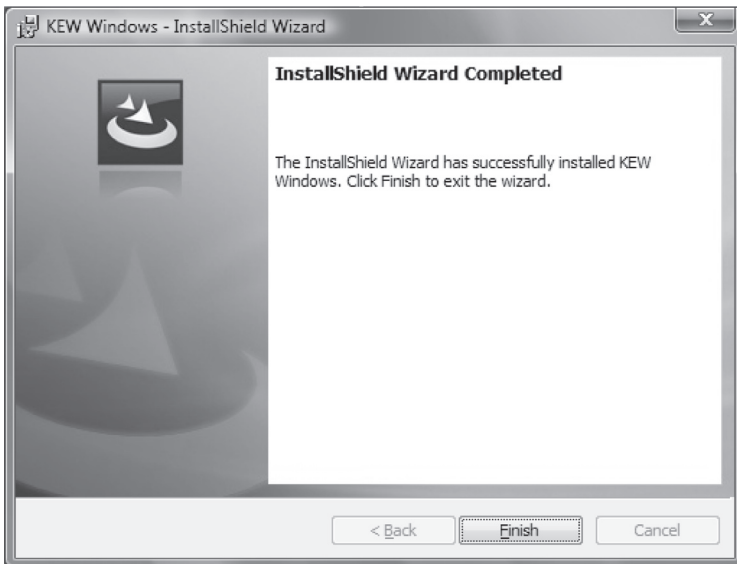

- ⑦ An installation of “KEW Windows for KEW3128” is followed by the installation of “KEW Windows” .



- To install the “KEW Windows for KEW3128”, you can follow the same installation procedure described for “KEW Windows” .

If you need to remove this software, use the “Add/Remove Programs” tool in the Control Panel.

8.2 How to start “KEW Windows for KEW3128”

● Start and Quit

Start the software by; 1) clicking the icon for [KEW Windows] on the desktop, or 2) clicking [Start] → [Program] → [KEW] → [KEW Windows]. Then the KEW products, which have been installed in the “KEW Windows”, are listed up. Select the “KEW3128” on the list, and then click “Next”. Then a main menu for “KEW Windows for KEW3128” appears. Click [Data Download] or [Instrument Setting].



9. Accessories

9.1 Metal parts for Line Probe, and replacement

① Metal Parts

Standard, Hook Type: To be used to hook the instrument.

(Shipped out with being attached to the Line Probe)

MODEL 8029: Tip metal, Straight Type (accessory)

② How to replace the metal parts

Turn the Line probe counterclockwise to remove the attached tip metal.

Put the tip metal you want to use to the hexagon socket and turn it to clockwise together with the tip of probe, and tight up screws.

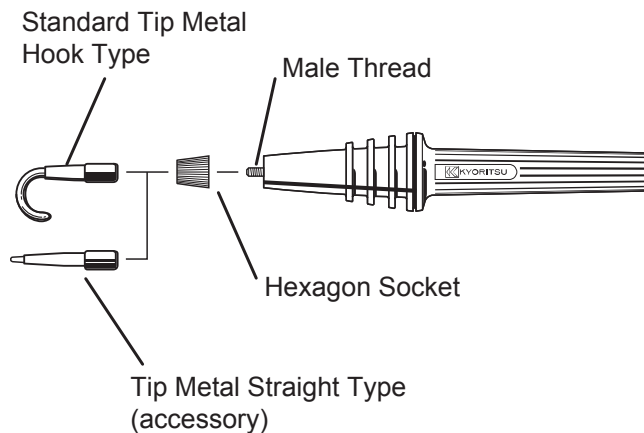

10. Disposing the Product

Waste Electrical and Electronic Equipment (WEEE), Directive 2002/96/EC

This Product complies with the WEEE Directive (2002/96/EC) marking requirement. The affixed product label (see below) indicates that you must not discard this electrical/electronic product in domestic household waste.

Product Category

With reference to the equipment types in the WEEE directive Annex 1, this product is classified as a “Monitoring and Control instrumentation” product.



Disposing lead-storage batteries

When you throw away the batteries, be sure to cover their positive and negative terminals and always observe local laws and regulations.

Insufficient insulation of the terminals may cause explosion or fire because electrical energies remain in lead-storage batteries after use.